

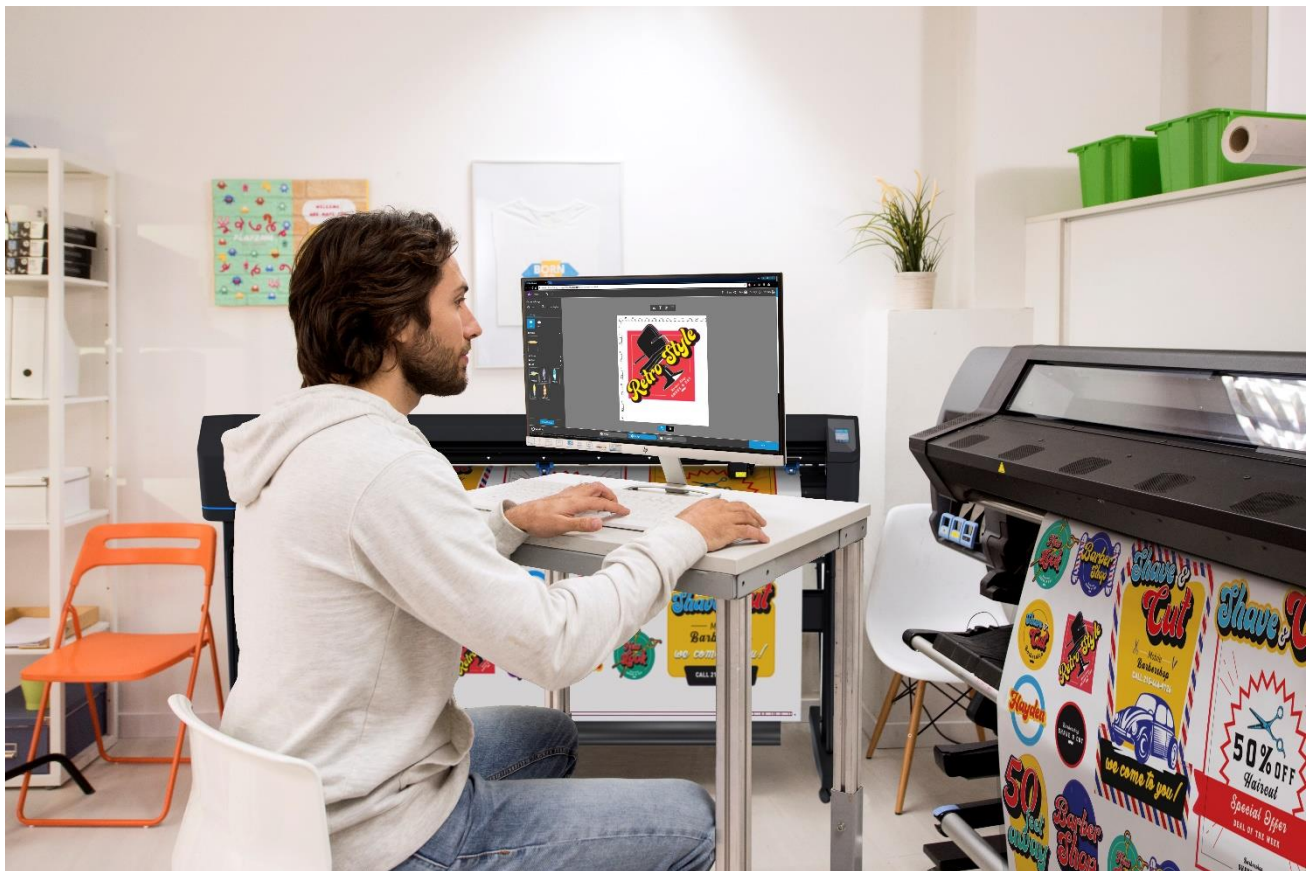

# Cookbook - HP Latex Print and Cut Plus Solutions



# 1 Table of contents

Table of contents.....	2
Overview.....	4
1.1 Who can benefit from reading this document? .....	4
The HP Latex Print and Cut Plus Solutions.....	5
2.1 HP Latex Print and Cut Plus Portfolio .....	5
2.2 Multiple applications for print and cut .....	5
How to get the best results from the HP Latex Print and Cut Plus Solution .....	6
3.1 Workflow .....	6
3.2 Job creation.....	6
3.2.1 HP Applications Center overview.....	6
3.2.2 Benefits of HP Applications Center .....	7
3.2.3 Example.....	7
3.2.4 How to create an HP Applications Center account.....	8
3.3 Job edition and management – RIP .....	8
3.3.1 Job workflows.....	8
3.3.2 Adding contour marks .....	9
3.3.3 Print marks.....	9
3.3.4 How to add print marks.....	10
3.3.5 Job alignment .....	11
3.3.6 Printing parameters.....	11
3.3.7 Cutting parameters.....	13
3.4 Print.....	15
3.4.1 Printer setup.....	15
3.4.2 Send.....	16
3.5 Cutting.....	16
3.5.1 Loading the substrate.....	16
3.5.2 Cutting tool .....	17
3.5.3 User configurations.....	18
3.5.4 Calibrations .....	18
3.5.5 Finding the cutting settings for your substrate.....	19
3.6 Cutting presets.....	22
Tips for substrates.....	23
4.1 Getting the right cutting accuracy .....	23
4.2 Self-adhesive vinyls .....	26
4.3 Transfer media.....	26

4.4	Transparent / translucent films.....	26
4.5	Laminates.....	27
4.6	Perforated SAV.....	27
4.7	Self-adhesive textiles.....	28
4.8	Reflective graphic films.....	29
	<a href="#">Useful links.....</a>	<a href="#">30</a>

## 2 Overview

### 2.1 Who can benefit from reading this document?

This document is intended for:

- Owners and operators of the HP Latex 115 Print and Cut Plus Solution, the HP Latex 315 Print and Cut Plus Solution and the HP Latex 335 Print and Cut Plus Solution.

This document provides information about:

- The main features and possibilities of the HP Latex Print and Cut Plus Solution.
- The HP Latex Print and Cut workflow.
- How to get the best results for a wide range of applications and substrates.



# 3 The HP Latex Print and Cut Plus Solutions

## 3.1 HP Latex Print and Cut Plus Portfolio



		HP Latex 115 Print and Cut Plus Solution	HP Latex 315 Print and Cut Plus Solution	HP Latex 335 Print and Cut Plus Solution
HP Latex printer	Max media width	137.1 cm (54 inches)		162.5 cm (64 inches)
	Max loading	25 kg (55 lb.)		42 kg (92.6 lb.)
	HP Latex Inks	HP 821 Latex Ink 400 mL cartridges	HP 831 Latex Ink 775 mL cartridges	
HP Latex cutter	Cut width	135 cm (53.1 inches)		158 cm (62.2 inches)

HP also offers the **HP Latex Cutting Solutions**, which include an HP Latex Cutter and the HP FlexiPRINT and CUT RIP. There are 3 models available:

	<p><b>HP Latex 64 Plus Cutting Solution</b> Expand into wider applications with this 64-in cutting solution</p>
	<p><b>HP Latex 54 Plus Cutting Solution</b> Grow with this 54-inch business-ready cutting solution</p>
	<p><b>HP Latex 54 Basic Plus Cutting Solution</b> <i>(only available in AMS region)</i> Start—with this easy to use, affordable 54-in cutting solution</p>

All HP Latex Cutting Solutions can be directly connected to HP Latex 115, 315, 335, 365, 700 and 700W printers because the HP FlexiPRINT and CUT RIP supports them. In order to connect an HP Latex 800 or 800W printer, an upgrade from the HP FlexiPRINT and CUT RIP to the HP FlexiSIGN & PRINT RIP is always required.

## 3.2 Multiple applications for print and cut



Labels & stickers



Custom clothing



Floor graphics



Wall decals



Window graphics



Vehicle graphics

# 4 How to get the best results from the HP Latex Print and Cut Plus Solution

## 4.1 Workflow

Job creation	Job edition and management	Print	Lamination	Cut
<p>Wall Decoration apps and HP Signage Suite</p> <p>Design in 3 simple steps.</p>	<p>HP Flexi Print and CUT RIP and Production Manager</p> <p>Edit your images. Automatic cut lines. Generic cut and print profiles. Automatically includes the HP Barcode and OPOS Configurations.</p>	<p>HP Latex 115/315/335 Printer</p> <p>High quality with speed. Instant-dry. X-axis cutter.</p>	<p>Avoid laminating <b>short term jobs</b> with scratch-resistant prints. <i>If required,</i> laminate after printing.</p>	<p>HP Latex Plus Cutter</p> <p>Reliable and unattended cutting. High cut speed.</p>

## 4.2 Job creation

### 4.2.1 HP Applications Center overview

HP Applications Center is a **Cloud-based application** used to customize wall decoration and signage applications, as well as for residential, retail or commercial purposes. Further information can be found at: <https://www.hpapplicationscenter.com/>. Also available inside HP PrintOS.

It includes several applications, which are listed below:



Wallcovering



Canvas



Face Mask



Posters



Gift Wraps



Roll-ups



Banner

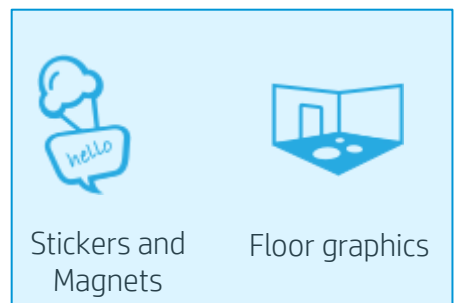

Stickers and Magnets

Floor graphics

 : Using Print and Cut

## 4.2.2 Benefits of HP Applications Center

These are some of the **outstanding features** offered by the HP Applications Center:

- Friendly 3-step design tool designed for **non-expert users**.
- **3D visualization** for applications requiring it.
- Access to content libraries.
- Predefined templates.
- **Easy management** of production, customers, and content.
- Automatic **ready to print PDF** generation, which saves time and reduces errors.
- Automatic job **downloads with JDF support** and PDF file versioning control.
- **Easy integration** into PSP websites: External hyperlinks, CRM plugins based on pre-defined templates or API website integration.
- **Print and Cut technology** used in several apps.

### 4.2.3 Example

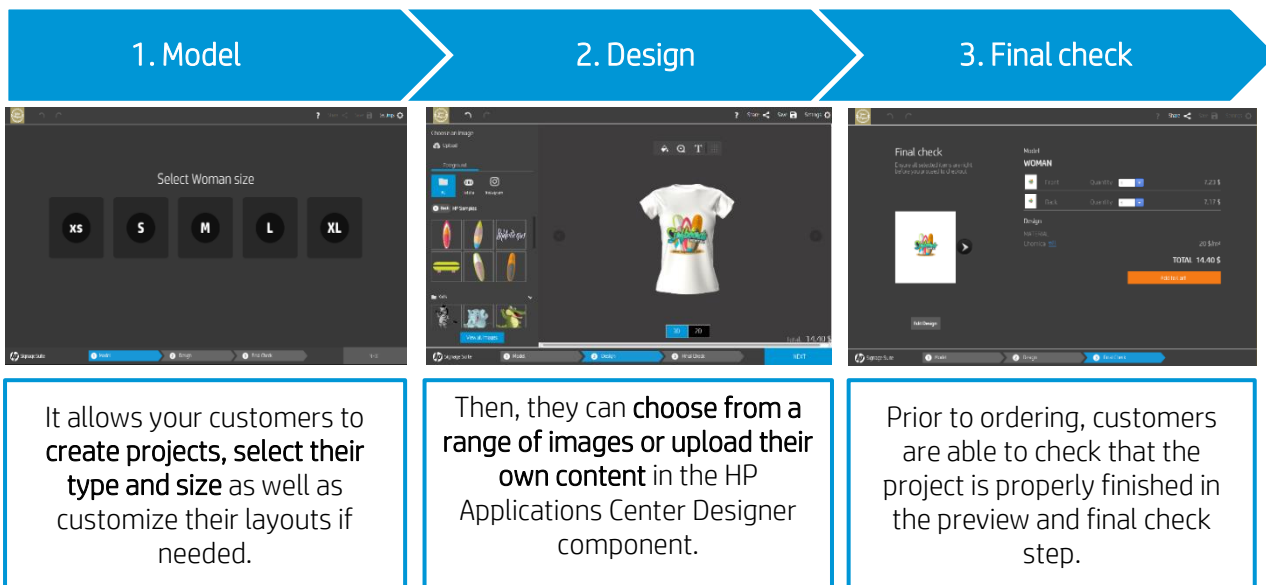

As a PSP, you are able to access a dashboard containing the orders received, where you can download them as **ready-to-print PDF** files. It allows for the creation of a personalized experience with an integrated end-to-end process including **e-commerce capabilities**.

Remember, integration to your website can be done by following two alternative paths:

- Either by using the plugin, or
- with the API itself.

## 4.2.4 How to create an HP Applications Center account

You can create an HP Applications Center account on the website [www.hpapplicationscenter.com](http://www.hpapplicationscenter.com). There, you will see that there are two options: Lite and Pro.

As for entering HP Applications Center Pro, this is **free**. You only need to **register your HP Latex printer** by providing its serial number during the registration process.

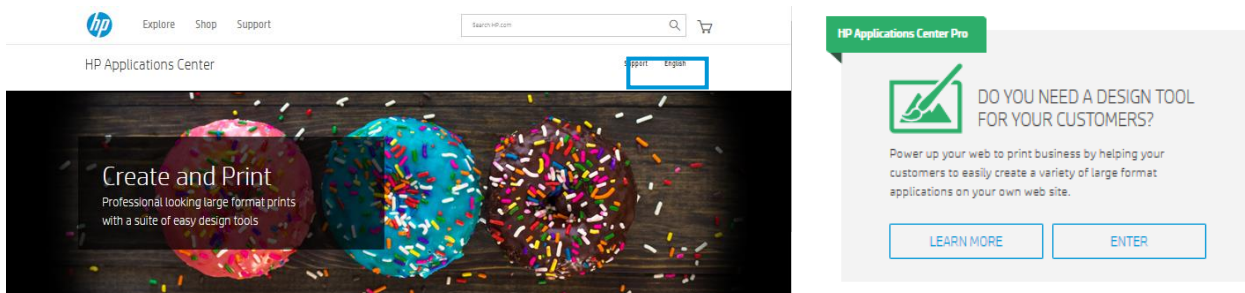

Also, you can access your HP Applications Center account from your connected **PrintOS** account.

## 4.3 Job edition and management – RIP

Jobs can be created with HP Signage Suite, HP Flexi Print & Cut, or with any other graphic design software.

The following sections briefly explain the steps required to prepare your job with the HP Flexi PRINT and CUT **RIP** and to get ready to print and cut.

### 4.3.1 Job workflows

There are 3 main workflows:

1. Files **with contour marks** – Directly to [Production Manager HP Edition](#).
2. Files **without contour marks** – Edit with [HP Flexi Print and Cut Editor](#).
3. **Direct cutting** – Edit with [HP Flexi Print and Cut Editor](#).







### 4.3.2 Adding contour marks

HP Flexi PRINT and Cut Editor allows you to select the paths in your image file and to add the contour marks:

**Add contour lines – Effects menu > Contour cut.**

Some image types may require further steps:

Vectors / masks	Bitmaps / color traces	Direct cut
 Remove any unnecessary background, and select only the outline paths you want to add a contour line to.	 For bitmaps, make the background transparent.   The Color Trace option helps to create a higher quality contour cut.	In this case, no contour lines are needed.   Create your design and cut/plot.

Refer to Getting the right cutting accuracy section of this document for additional tips on contour marks.

You can find further details in the HP Flexi Print and Cut Editor tutorial: *Help menu > Flexi Tutorial.*

### 4.3.3 Print marks

Print marks are elements added to your job using the RIP, that later will be read by the cutter’s **Optical Positioning System (OPOS)** sensor, making it possible to have a highly accurate contour cut.

The **OPOS sensor** is mounted underneath the carriage tool and detects the various registration marks printed on the substrate:

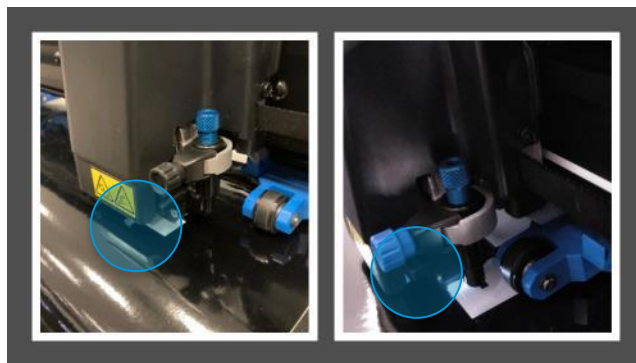

These print marks have the function of positioning, compensation and job identification:

1. **OPOS** (registration marks): Small squares that help the cutter to locate the job accurately, and to compensate for skew and deformation.
2. **OPOS** lines:
  - a. **OPOS XY** - A line at the beginning of the job that helps the cutter to compensate for deformation across the width of the job (bow deformation).

- b. **OPOS XY2** - Same as the OPOS XY line but added at the end of the job to help the cutter better compensate for the deformation along the whole job.
  - c. **OPOS Xtra** - Adds horizontal lines between rows of images in the same job to help further compensate for any bowing.
3. **HP barcode:** A code that can be placed on both sides of the job, improving productivity, as you can feed in the substrate starting at either end.

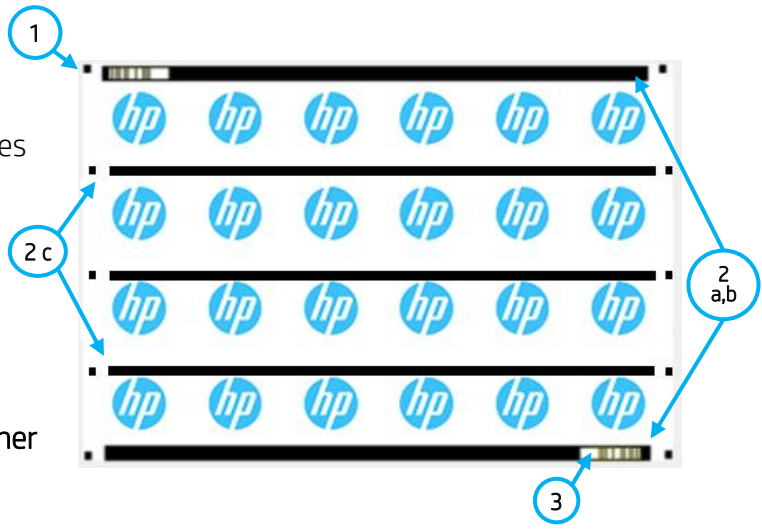

### 4.3.4 How to add print marks

Print marks can be found under the HP barcode options. Here, you can select different options: OPOS, OPOS XY, OPOS XY2 or OPOS Xtra, and activate or deactivate the HP barcode for job identification.

#### HP Flexi PRINT

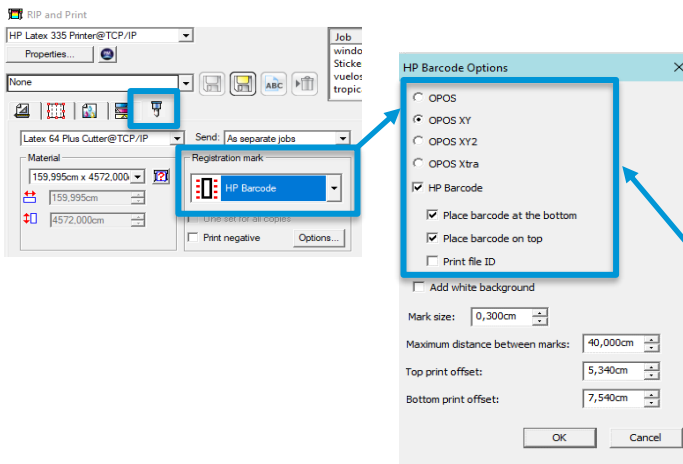

#### Production Manager

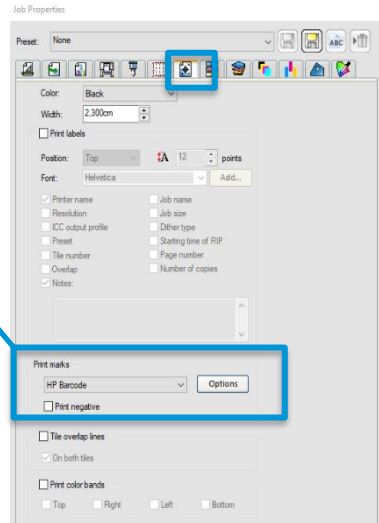

### 4.3.5 Job alignment

By default, jobs are aligned on the **right side of the substrate**.

It is important to use the **same alignment for all the jobs** you wish to print and cut together on the same substrate to ensure that the sensor can read the HP barcodes of consecutive jobs.

#### HP Flexi PRINT

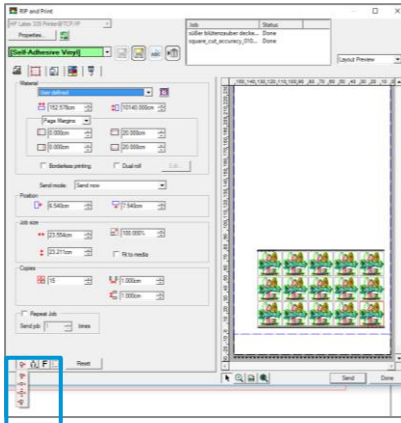

#### Production Manager

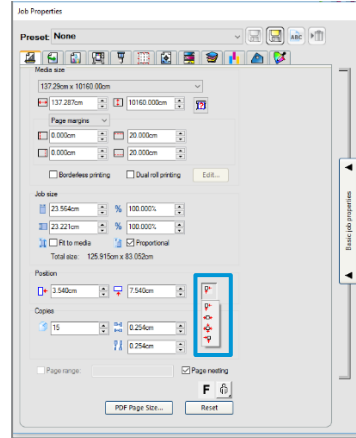

### 4.3.6 Printing parameters

In order to get the best results from your substrate, printer and cutter, set up your printer options as follow. Please note that words **substrate** and **media** are used indistinctively here.

#### Set substrate presets

##### Option 1. Using HP Flexi Print and Cut Editor

- 1a. Go to RIP and Print.
- 1b. Go to the **Advanced Options** menu.
- 1c. Choose **Use color correction**.
- 1d. Select the correct **Output profile**.
- 1e. Select the **Media** you have loaded in the printer.
- 1f. Select the highest resolution: **600x600 dpi**.

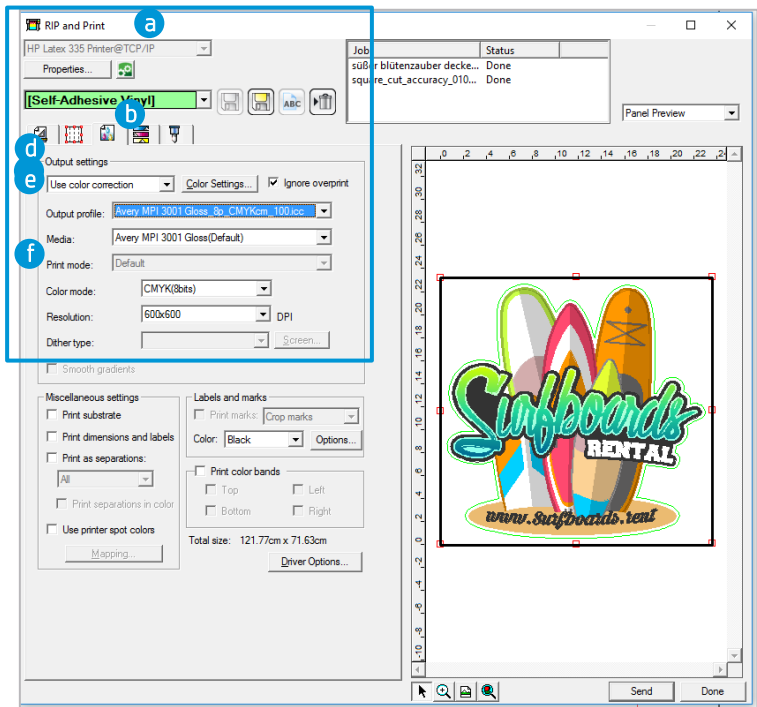

### Option 2. Using Production Manager HP Edition

2a. Select your job, and go to **Job Properties**.

2b. In the **Printer Options** menu:

- a. Click on **Read media** from printer.
- b. Click **Download ICC**.
- c. Choose the correct **Category, Media and Print Mode**.

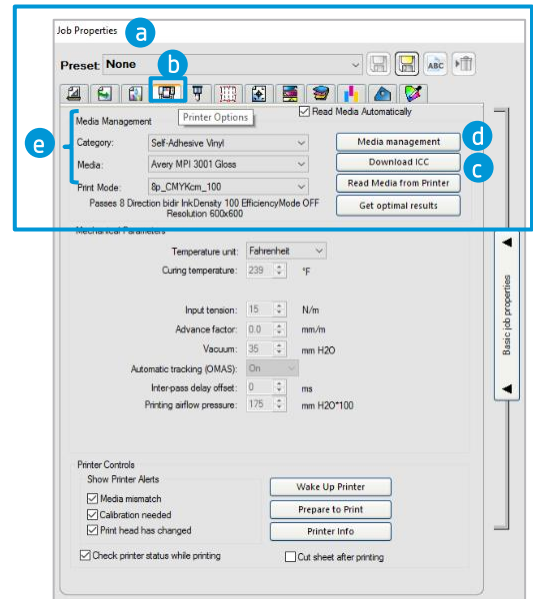

2c. Finally, in the **Color Management** menu:

- a. Choose **Use color correction**.
- b. Select the correct **Output profile**.
- c. Select the **Media** you have loaded in the printer.
- d. Select the highest resolution: **600x600 dpi**.

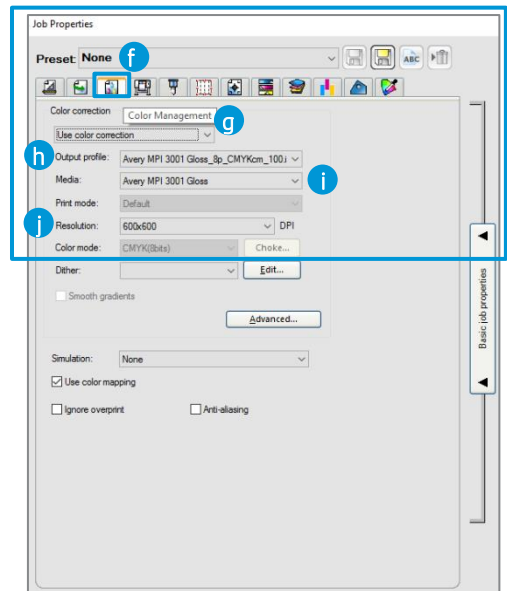

### How to install your substrate presets

If you are using a substrate which is [Certified for HP Latex inks](#), you can use its substrate preset. You can either install these from the **printer's front panel** or download them from the **PrintOS Media Locator**. You can also create your **own specific substrate presets**.

### Option 1. Install from the printer's front panel

1a. Click on the **Online Search** button.

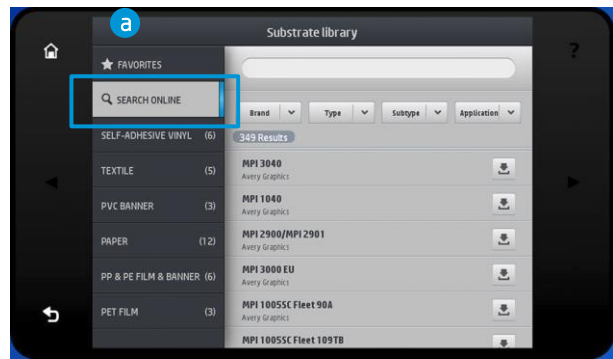

1b. Then, filter by **Type**, **Brand**, **Classification** and **Application**; select the substrate from the drop-down list.

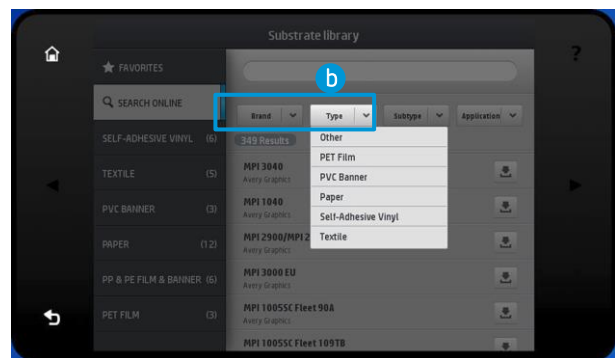

1c. Once you have located the substrate preset of your choice, tapping the **download** icon will queue it for automatic download and installation, which is done in the background.

1d. Supported RIPs synchronize their substrate preset lists with the printer, so that the printer and the RIP will always have the same list.

### Option 2. Download your substrate preset from PrintOS Media Locator

2a. All the substrate presets are available from the HP Media Solutions Locator, which is an application within PrintOS: <https://www.printos.com/ml/#/medialocator>.

### Create your own substrate preset

- Finally, if you cannot find a ready-made preset for your substrate, and if you prefer not to use a generic preset or edit an existing one, you can [make your own preset from scratch](#).
- The **Add New Substrate** wizard in the printer's front panel guides you in establishing the best settings for your substrate.
- Full instructions can be found in the printer's **User Guide**.

### 4.3.7 Cutting parameters

Define the **type of cut** and the **cutting parameters** for each contour mark of your job according to the substrate you are using.

As a starting point, you can select the cutting presets that are already stored in your **HP Flexi Print and Cut Editor** and **Production Manager HP Edition**.

Section 4.5.5 explains how to find the correct cutting settings according to your substrate.

**Setting the cutting parameters**

**Option 1. Using HP Flexi Print and Cut Editor**

- 1a. Go to **RIP and Print**.
- 1b. In the **Contour** menu, you can set specific cutting parameters for each contour mark.
- 1c. Choose a **cutting preset** with default cutting parameters.

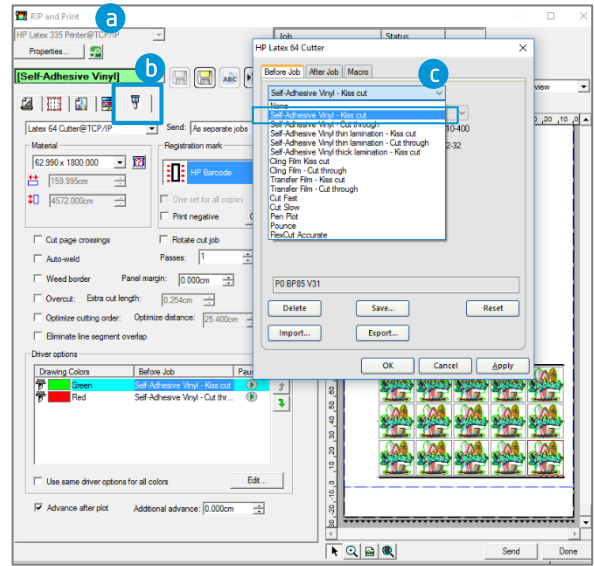

**Kiss cut parameters**

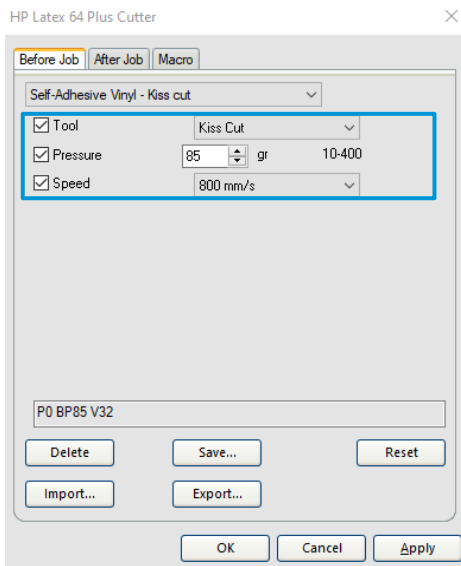

**Cut-through (FlexCut)**

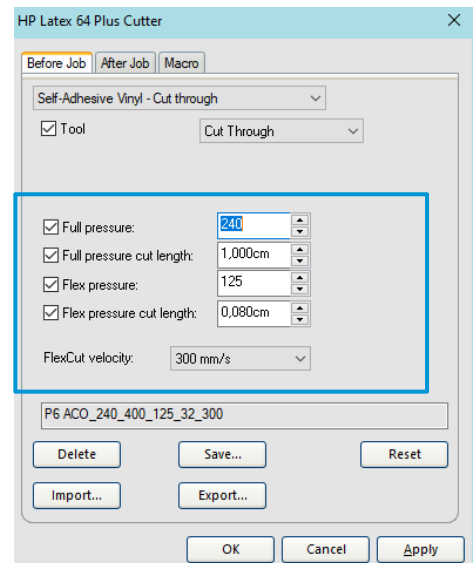

- 1d. You can also modify your cutting parameters according to the results obtained in the tests described in section [3.5.5 Finding the cutting settings for your substrate](#). Save the new preset with a different name.
- 1e. To use the cutting settings previously stored in the cutter's **user configuration**, uncheck the cutting parameter check boxes.

**Option 2. Using Production Manager HP Edition**

- 2a. Select your job from the printer or cutter queue.
- 2b. Then go to **Job Properties > Cut** menu.

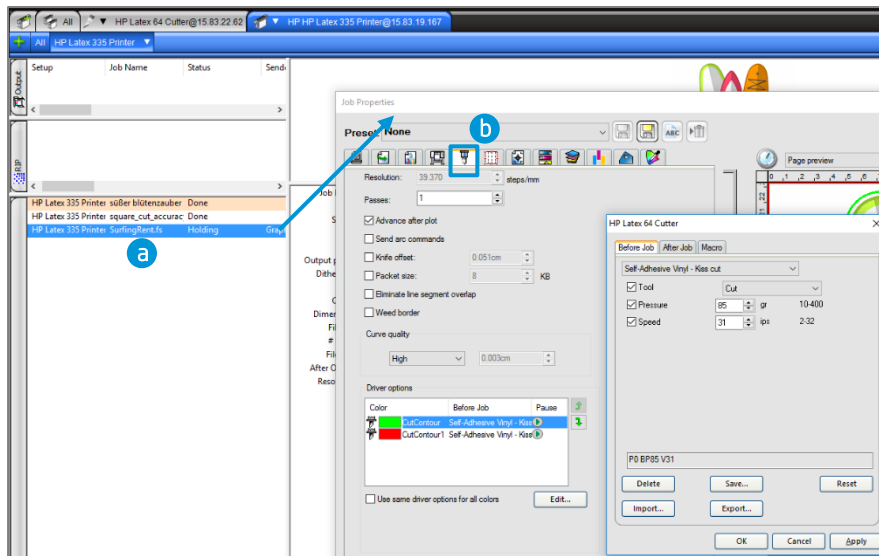

The next steps are as explained above in [Option 1. Using HP Flexi Print and Cut Editor](#).

## 4.4 Print

### 4.4.1 Printer setup

Please consider using [HP Latex Certified](#) substrates in order to get the best printing performance.

Make sure that the substrate type that you select on the front panel and in your RIP is the same as the substrate type that is loaded in the printer.

Make sure that the substrate has been calibrated:

- Substrate-advance calibration (if needed)
- Printhead alignment
- Color calibration

Please refer to your printer's User Guide for an extended explanation on **How to handle the substrate** and **Substrate settings**.

**IMPORTANT:** Some substrates may deform when they have been loaded in the printer for several hours and not printed on. In order to prevent possible printhead crashes during loading, advance the substrate forward until the deformed area passes the printing zone.

### 4.4.2 Send

After editing and preparing your job, it can be sent to be printed from either the **HP Flexi Print and Cut Editor** or from **Production Manager HP Edition**.

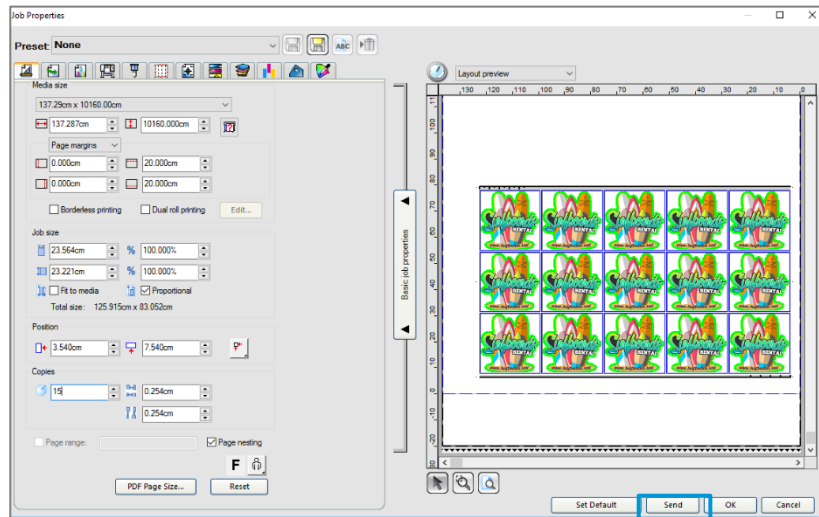

## 4.5 Cutting

After the job is printed, you can load the substrate directly onto the cutter.

### 4.5.1 Loading the substrate

Sheet format



- Load from the front or the rear
- Use alignment marks – ruler

Rolls

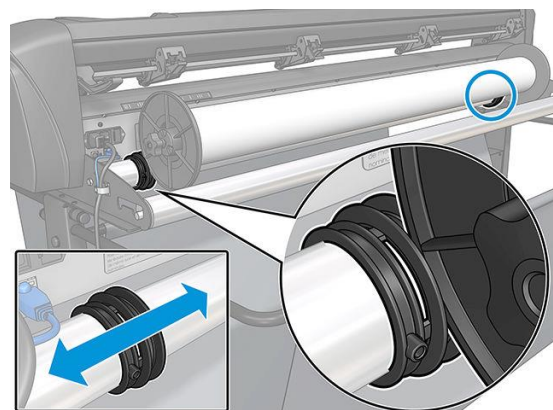

- Load from the rear
- Use media flanges for better media advance

Follow the instructions in chapter 3 of the User Guide.



When **using the HP barcodes**, there is no need to re-send the job from your computer to the cutter. It will retrieve the cutting info from the RIP as long as you keep it in the job queue. In addition, you do not need to worry about job orientation when loading it on the cutter.

When **not using HP barcodes**, you have to send the job to the cutter directly from **Production Manager HP Edition**; in this case, load the job on the cutter so that the first OPOS mark to be read is the one closest to the lead printing edge of the plot.

### 4.5.2 Cutting tool

#### Type of knife

It is recommended to use the proper type of knife for each type of substrate.

Please follow the indications below, which are based on the thickness of the substrate:



Substrate thickness (mm)	36° Drag Blade Standard	60° Drag Blade Specialty
Max. Kiss Cut	0.25	0.60
Max. Cut Through	0.50	0.60

#### Knife depth

Knife depth must be increased when using thicker types of vinyl and decreased when using thinner types of vinyl. In any case, only the knife tip should stick out beyond the knife holder, as shown:

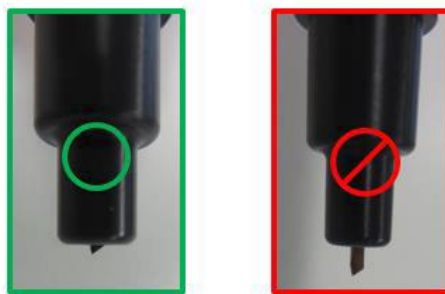

### 4.5.3 User configurations

There are four user configurations of **cutter parameters**. The parameters can be set to different values for each user, so that you can reconfigure the cutter for a different type of job or substrate quickly and easily by selecting a different user.

- Change user: *Tap current User on the front panel*



**NOTE:** You can change the user’s names via the HP Cutter Control tool from your PC.

### 4.5.4 Calibrations

Some calibrations need to be performed in order to get the best possible cutting accuracy.

From the cutter’s front panel: Tap  > *Calibrations*.

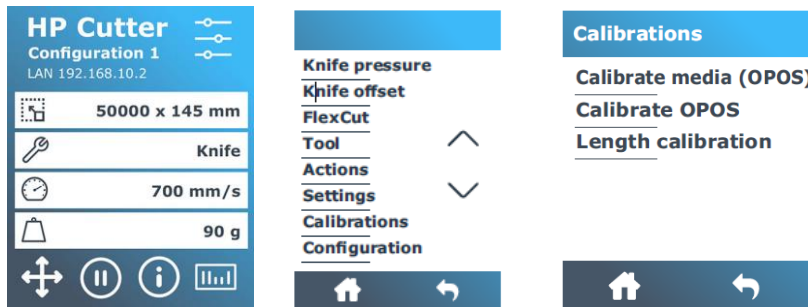

#### Calibrate media (OPOS)

This action calibrates the reflection levels of the marker color and the substrate color.

Perform this calibration when using colored, translucent, high-gloss or reflective substrates.

**IMPORTANT:** Prior to performing the calibration with the cutter, a set of calibration patches need to be printed on the **same substrate as the cutting job**. Please follow these steps:

1. Load, in the printer, the substrate you will use for your print and cut job.
2. Before printing your job, print a black square (100 CMYK).

3. Load the printed chart in the cutter.

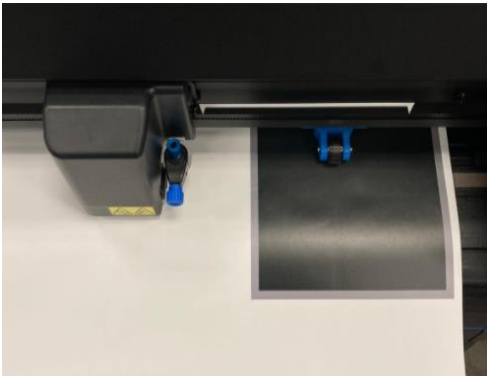

4. On the cutter's front panel, tap: *Calibrations > Calibrate media (OPOS)*

5. Follow the front panel instructions; you will be asked to position the OPOS sensor above each color patch, including the non-printed area.

### Calibrate OPOS

Calibrates the distance between the knife and the sensor.

Perform this calibration whenever you install a new knife. Use a black vinyl or a black printed patch.

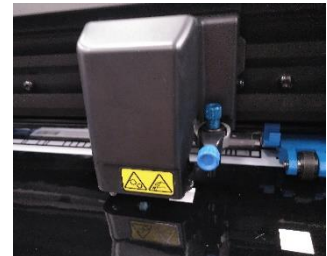

### Length calibration

**NOTE:** Perform this calibration only when experiencing issues with substrate advance in the cutter, e.g. with substrates thicker than or having different grip than modern-day self-adhesive vinyls.

This calibration allows the length of the cut lines to be adjusted to within specifications.

The cutter will make two marks (arrows 1 and 2), and the user needs to measure the distance between them and enter the value in the cutter.

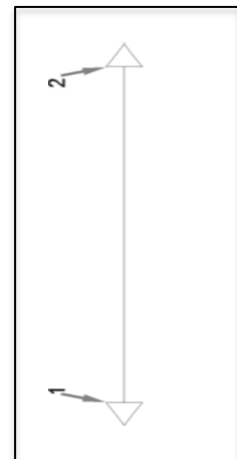

#### 4.5.5 Finding the cutting settings for your substrate

The cutting presets available in Print and Cut are intended for a limited number of media categories that may not include your specific substrate. Also, the wear on the knife can affect the cutting result.

For these reasons, **it is highly recommended to find the right cutting settings** prior to sending a print-and-cut job.

### For Kiss cuts (contour cuts)

- The knife cuts completely through the vinyl and slightly into the liner:

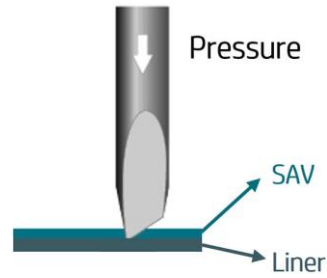

*Menu > Knife Pressure > Test*

- Check your current knife pressure from the cutter's front panel:

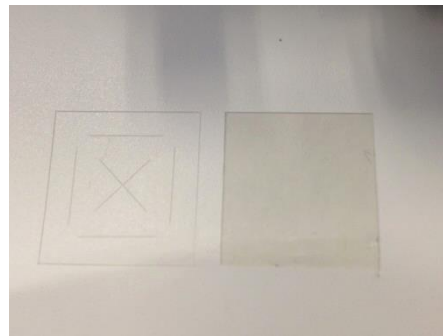

The knife pressure is set correctly when the test pattern cuts completely through the vinyl, the vinyl is removed, and the blade tip has visibly scratched the front side of the substrate backing (liner). The blade should never cut through the backing.

- If the result is **not OK**, increase or decrease the knife pressure value and test again.
- This setting can be stored in a given **user's** configuration.

### For Cut-throughs (FlexCut)

- The knife cuts completely through the substrate at some points, and just through the vinyl at others (bridges).

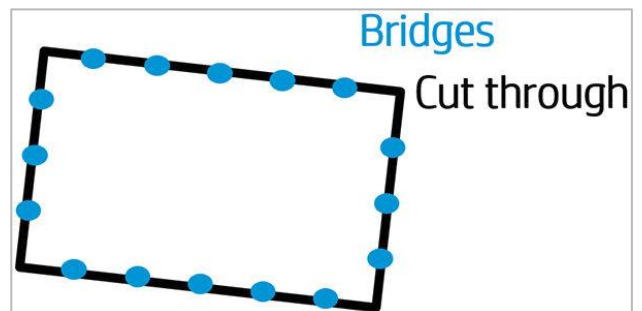
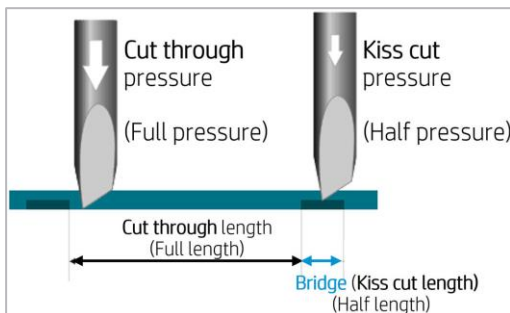

- Check current FlexCut performance from the cutter's front panel: **Menu > FlexCut > Test**. The setting is correct when the substrate is cut completely through but the test pattern stays together, so it can later be torn out.

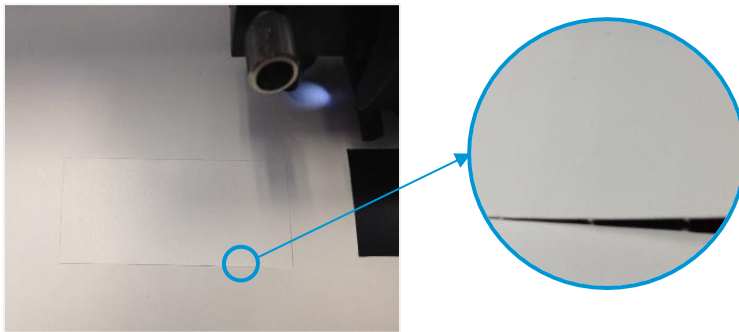

- Adjust the FlexCut settings and test.



- These settings can be stored in a given user's configuration as well.

**NOTE:** The FlexCut option is only reliable with simple shapes like **circles, rectangles, and ovals**.

## 4.6 Cutting presets

The following settings correspond to the **generic presets** provided in the [HP Flexi Print and Cut](#) software.

Use these values as a starting point for adjusting the cutting parameters to your specific substrate.

	Kiss Cut	Cut-through	
Substrate	Pressure (g)	Full Pressure (g)	Half Pressure (g)
Self-Adhesive Vinyl	85	240	125
Self-Adhesive Vinyl thin lamination	170	265	200
Self-Adhesive Vinyl thick lamination	225	N/A	N/A
Cling Film (PET)	210	380	230
Transfer Film (PP)	135	175	155

**NOTE:** The above presets are set for the **standard** knife type.

# 5 Tips for substrates

## 5.1 Getting the right cutting accuracy

- Download media presets recommended for Print & Cut:

1. Via the Printer's Front Panel:

*Substrate library > Online Search > Filter by Application > Print & Cut.*

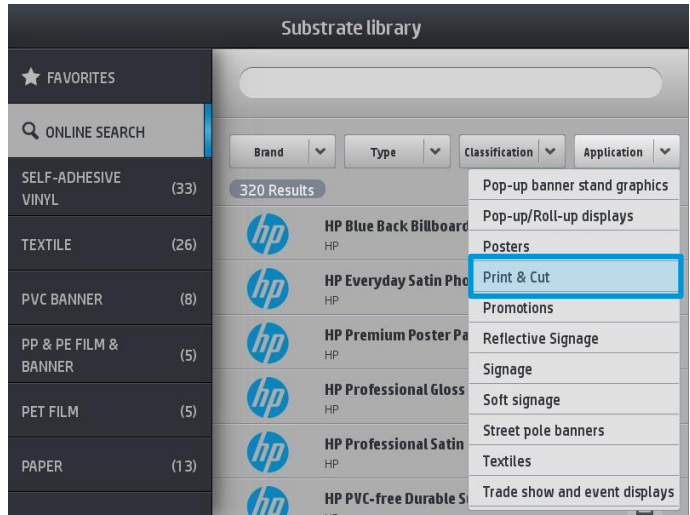

2. Via PrintOS Media Locator: <https://www.printos.com/ml/#/medialocator>

*Choose Latex platform > Filter > Application > Print & Cut.*

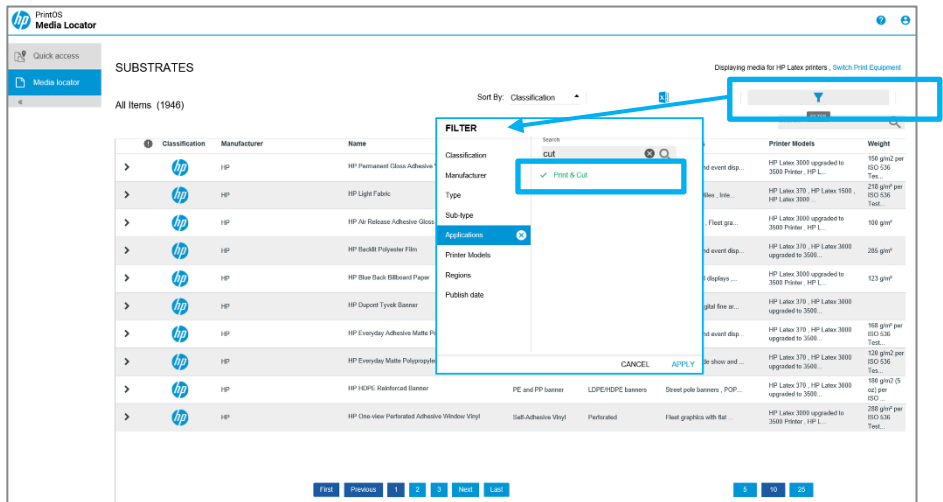

- For self-adhesive vinyls, please also follow the tips mentioned in section [4.2 Self-adhesive vinyls](#).

- Place the **cutting path** inside the contour edge (**bleed**) or outside (**choke**):

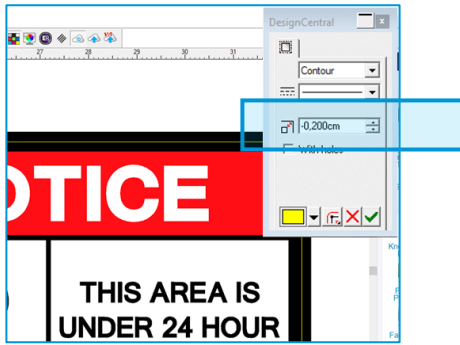

💡 Insert negative values when in bleed; use positive values for choke.

- Use the OPOS mark HP barcode.  
Try to use compensation modes in this order:

Setting	Level of bow compensation
OPOS XY	low
OPOS XY2	middle
OPOS Xtra	high

- Set OPOS panels to ON, from the cutter's front panel:

*Settings menu > Configuration > OPOS parameters > OPOS paneling.*

When ON, this option allows the markers to be read in panels. The OPOS sensor reads markers according to panel size, instead of loading them all; when set to ON, the sensor will load only two markers in the X direction when loading OPOS. Other markers will be read when unrolling the substrate.

This option is set by default when using OPOS Xtra.

- Reduce job sizes** (i.e., use fewer rows of images) if using OPOS XY or XY2, and print several copies of a job; in this manner, more **horizontal bars** will be printed and the OPOS sensor will be able to readjust the alignment. In case of printing jobs with a large number of rows, use OPOS Xtra.



- Reduce the 'velocity' parameter: You can modify this parameter from the cutter's front panel or via the RIP:

### Cutter's front panel

Menu > Settings > Velocity.

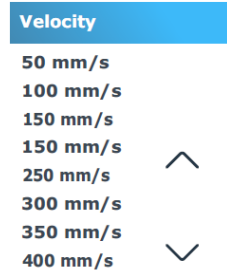

### RIP

Set the cutting speed in the RIP as required:

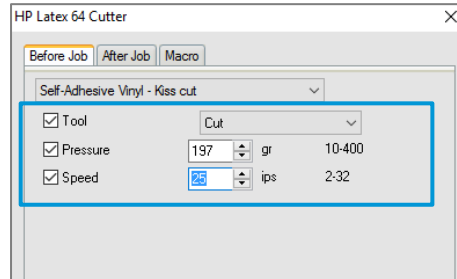

- Enable **Finishing for cutting** on the printer's front panel (**Settings > Setup > Finishing for cutting**). This option optimizes the curing process to improve length accuracy for Print & Cut jobs. This option is only available in HP Latex 300 Series printers.
- Add top and bottom margins to the print & cut job: set them to at least 10 cm.

Top and bottom edges of the plot can become wavy, making it difficult for the OPOS sensor to read the HP barcode correctly and apply an accurate alignment.

With no margins



Wavy edges

With margins



The substrate is flat in the cutting zone

From the printer front panel, set the **top margin** at the front panel, press , then **Substrate > Substrate handling options > Extra top margin**.

To set the **bottom margin** at the front panel, press , then **Substrate > Substrate handling options > Extra bottom margin**.

**NOTE:** The extra top/bottom margin set in the front panel is applied in addition to the top/bottom margin selected in the RIP.

## 5.2 Self-adhesive vinyls

According to their manufacturing processes and their chemistry, self-adhesive vinyls are classified as follows:

- Calendered monomeric
- Calendered polymeric
- Cast polymeric

Calendered types are more susceptible to undergoing deformations caused by high temperatures during the printing process. When this happens, the dimensions of the print will change, and this will affect cutting accuracy.

We recommend decreasing the curing temperature to 110°C for print modes **8p\_6C\_100%** and **10p\_6C\_110%**, especially for **calendered monomeric** and **calendered polymeric** self-adhesive vinyls.

**IMPORTANT:** It is possible to go below 110°C but, depending on the media used and the image's characteristics, in order to guarantee sufficient **ink curing**, you may need to reduce the ink density as well.

## 5.3 Transfer media

Find a detailed description and guide on how to customize clothing in the following document: [Customized Clothing with HP Latex Printers](#).



## 5.4 Transparent / translucent films

It can be difficult for the HP OPOS sensor to read the HP barcode correctly on transparent and translucent substrates.

Use a white background, such as a **white self-adhesive vinyl** to prevent incorrect readings:

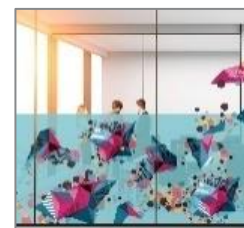

Step 1



Cut out a strip of a **white self-adhesive vinyl** approximately 1 cm wide in order to cover the cutting strip.

Step 2

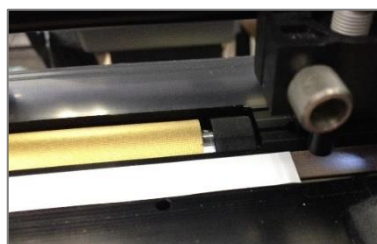

Stick the **white self-adhesive vinyl** strip over the whole length of the cutting strip.

Step 3

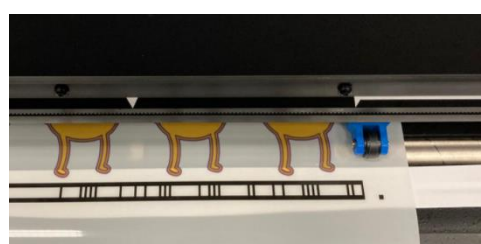

Load the substrate. Now the sensor can read the **HP barcode** and **OPOS lines and marks**.

## 5.5 Laminates

- With HP Latex printers you can laminate right after printing. Use the overlamine recommended by the manufacturer of your SAV.
- Cut off any part of a laminate film that remains over the edges of the self-adhesive sheet.
- Avoid the presence of bubbles, especially in the HP barcode and OPOS zones.

## 5.6 Perforated SAV

The OPOS sensor may not read the HP barcode correctly on some perforated films due to the nature of the substrate liner, which causes colored areas to have different color density between the vinyl and the liner area (see picture below).

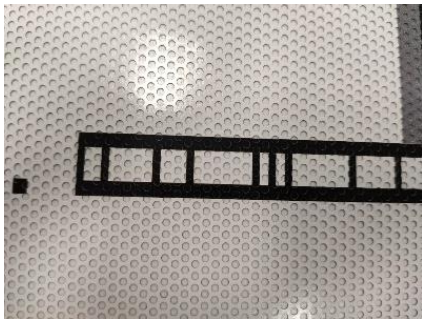

For this reason, neither OPOS XY marks nor HP barcodes would work very well.

In order to be able to **cut a job on perforated SAV**, we suggest the following workflow:

1. Perform **Calibrate media (OPOS)**.
2. If the HP barcode cannot be read, then prepare the job, selecting **OPOS** as the registration marks or print marks.

**IMPORTANT:** Note that, as no barcode is used, you will not be able to take advantage of unattended cutting or bowing compensation.

3. Send the job to **Print**.

- Load the printed job on the cutter:

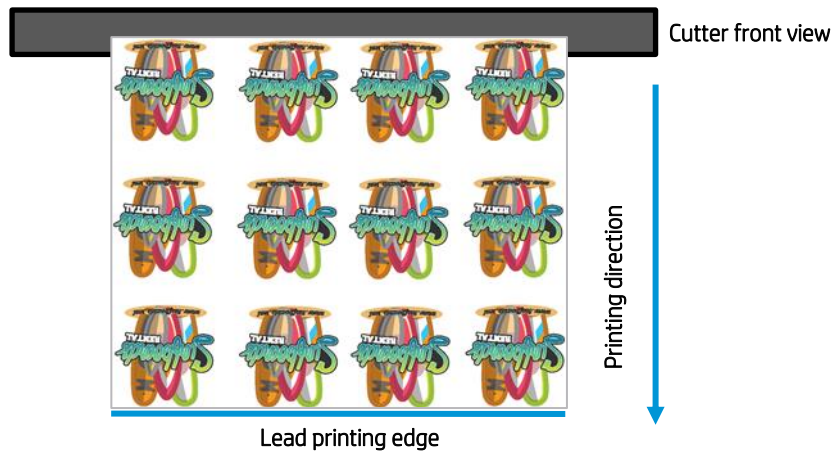

- As there is no barcode, the cutter will not start cutting right after loading the substrate. Send the job to the cutter from the **HP Production Manager cutter queue**.
- The cutter’s front panel will indicate that you “Set tool above first mark.” Move the sensor with the arrows to the first OPOS mark and tap . The OPOS sensor will search and read all OPOS marks and start cutting.

**IMPORTANT:** Note that, as no barcode is used, each cutting job will have to be sent separately from the **Production Manager** cutter queue.

### 5.7 Self-adhesive textiles

These substrates are used for interior decoration, in-store construction, and property design, in gastronomy and the hotel industry, and in the private sector as well. One example of such substrates is Mediatex® WallCover Textile, from Junkers and Müllers (HP latex ink certified).

For **printing** on this substrate, use the certified substrate preset, found in the printer’s online search or from the PrintOS Media Locator website: <https://www.printos.com/ml/#/medialocator>.

When **cutting**, you can follow the settings below as a starting point for setting the cutting parameters (using the **standard** knife type):

	Kiss cut	Cut through (FlexCut)	
		Full	Half
Knife pressure	190 g		
Velocity	400 mm/s		
Pressure		260 g	150 g
Length		10 mm	0.8 mm
Velocity		Auto	

Check if the result is satisfactory. If not, change any of the above parameters. Reducing the velocity can improve the result. Avoid using cutting speeds greater than **400 mm/s (16 ips)** with **cutting pressures above 170 g**.

## 5.8 Reflective graphic films

Reflective graphic films offer nighttime and daytime visibility for graphics and advertising. Their uses may include:

- Wraps for vehicles, straight trucks, semi-trucks and semi-trailers.
- Smooth and textured wall graphics, indoor and outdoor signs, including point-of-purchase graphics and displays.
- Bus graphics.
- Small format original equipment manufacturer (OEM) decorative and identification graphics, cautionary and safety labeling.



**IMPORTANT:** The following recommendations are limited to flexible, enclosed lens, retroreflective films, not thicker than 0.5 mm, and they do not apply to prismatic reflective films. Check the cutting instructions for your specific graphic substrate:

- Make sure the substrate is compatible with HP Latex inks and printers ([PrintOS Media Locator](#)).
- From the cutter's front panel, select a new **User** to save the new configuration specific for your reflective substrate: *Menu > User*.
- Check (and modify accordingly) the cutting settings for **kiss-cut** and **cut-through (FlexCut)**, by referring to [3.5.5 Finding the cutting settings for your substrate](#)). Note that some films may require the use of a sandblasted knife, while others may not even be recommended for cut-through jobs.
- **VERY IMPORTANT:** Perform the *Calibrate media (OPOS)* calibration (see [Calibrate media \(OPOS\)](#)); this calibrates the reflection levels of the marker color and the substrate color.

## 6 Useful links

Product documentation:

- <http://www.hp.com/go/latex115printandcut/>
- <http://www.hp.com/go/latex315printandcut/>
- <http://www.hp.com/go/latex335printandcut/>
- <https://www8.hp.com/us/en/printers/large-format/latex-plus-cutting.html>

User manuals:

- <https://support.hp.com/us-en/product/hp-latex-115-print-and-cut-plus-solution/33731728/model/33731729/manuals>
- <https://support.hp.com/us-en/product/hp-latex-315-print-and-cut-plus-solution/33731733/model/33731734/manuals>
- <https://support.hp.com/us-en/product/hp-latex-335-print-and-cut-plus-solution/33731738/model/33731739/manuals>

Print and Cut training:

- <https://hplatexknowledgecenter.com/blog/hp-latex-print-and-cut-plus-training>
- [How to create stickers with HP Latex 700 and HP Latex 800 Printer Series](#)

Further information:

- <http://www.hp.com/supportvideos>
- <http://www.youtube.com/HPSupportAdvanced>