

# How to create stickers with HP Latex 700 and HP Latex 800 Printer Series

This document will explain how to print and cut stickers of different types, including those printed with white ink and those with metallized effects.

A deep-dive training about [stickers on the HP Latex 700/800 Printer series](#) is available in the Learn App from your PrintOS account. See more details in [this article](#).



# How to create stickers

## What you will need

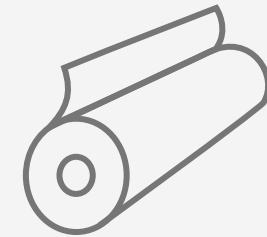
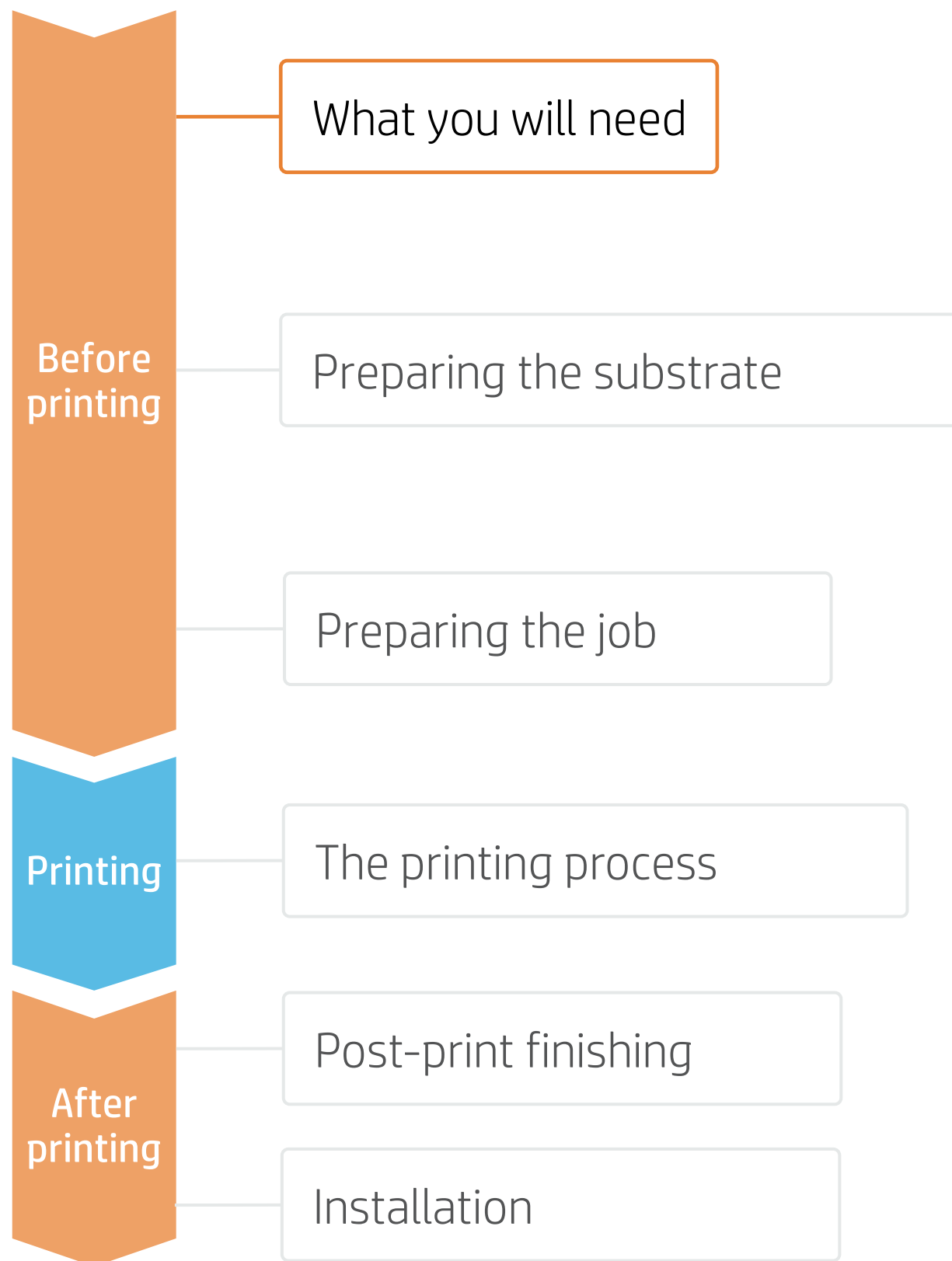

Self-adhesive vinyl or PVC-free film



SW tools (RIP, edition, etc.)



Printer



Cutting device  
HP Latex Cutter Plus



Film laminate (optional)



Film laminator (optional)

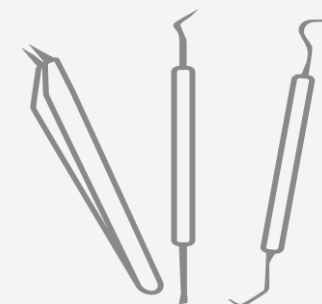

Weeding tool (optional)



Transfer tape (optional)

# How to create stickers

## Preparing the substrate

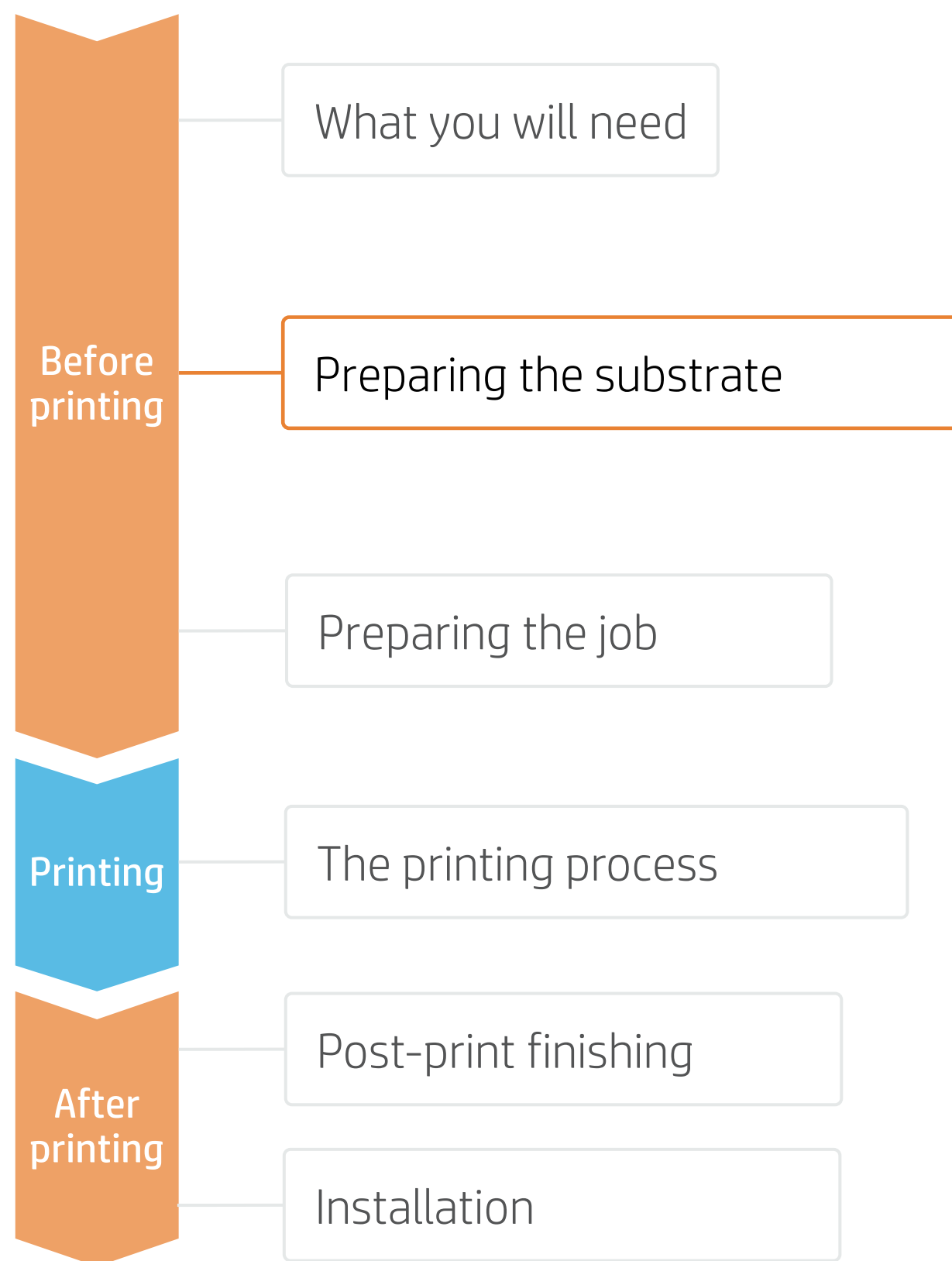

### 1. Types of self-adhesive substrates for stickers

#### By raw material

- Calendered monomeric
- Calendered polymeric
- PVC-free substrates
- Polyester films

#### Surface finish

- Gloss or Matte
- Color
- Transparent
- Metallic

#### By adhesive type

- Permanent
- Removable
- Repositionable
- Transparent or gray (opaque)

### 2. Usage

- Normally, graphics will be **short-term** (promotions and temporary events) and applied on **flat surfaces**.
- For **mid- and long-term** uses or **high-transit areas**, it is recommended to protect the graphics with **film lamination**.

**NOTE:** For **floor graphics**, we recommend using SAVs indicated for this purpose. Special adhesives are used for better adherence to the floor. Special **anti-slippage laminates** are also recommended.

### 3. Substrate presets

- Check that the material you are going to use has its own substrate preset:
  - a) On the **web**, in the HP PrintOS Media Locator: [www.printos.com/ml/#/medialocator](http://www.printos.com/ml/#/medialocator)
  - b) On the printer's **front panel** online search (Substrate Library)
  - c) On the **web**, from the substrate vendor's or RIP vendor's websites
- Download and install.

**NOTE:** If you cannot find the substrate presets, you can always use the **generic presets for self-adhesive vinyls or other generics** already installed in your printer. If you need to fine-tune some settings, clone the existing generic preset and modify it, or create a new one with the **Add new substrate** function on the front panel.

**TIP:** Learn how to customize your profile by enrolling on the available training: "HP Latex 700/800 Printer series – Advanced main tasks and maintenance routines" on the [Learn with HP website](#).

# How to create stickers

## Preparing the job

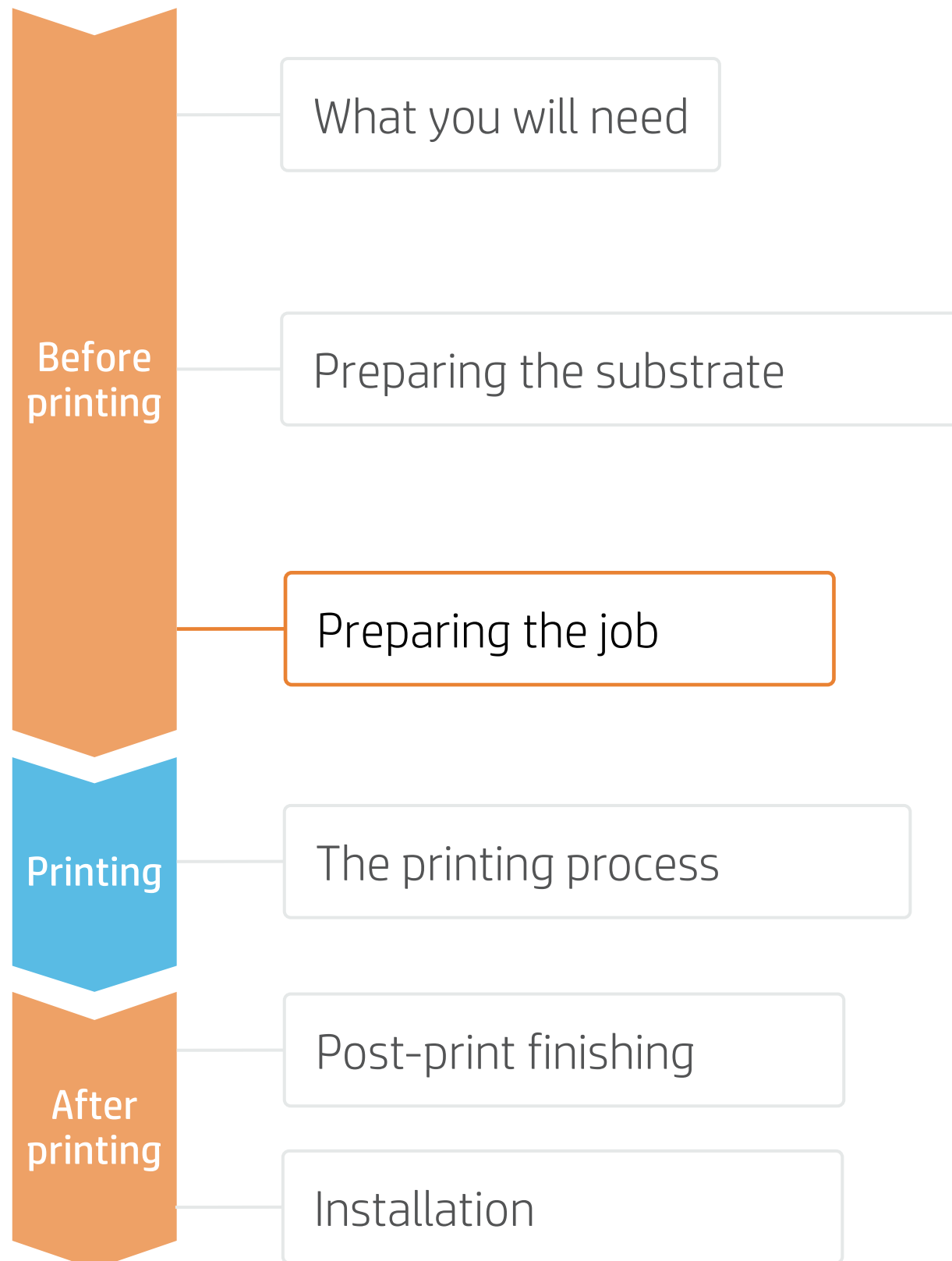

## 1. Software for designing and editing

Tools such as HP Applications Center (HP Signage Suite apps), Adobe Illustrator, Photoshop, and InDesign help you design and edit jobs and adapt them to your needs.



Make your decision based on your needs

### A. HP Signage Suite

HP Signage Suite is part of HP Applications Center, a complete package of tools to boost your business

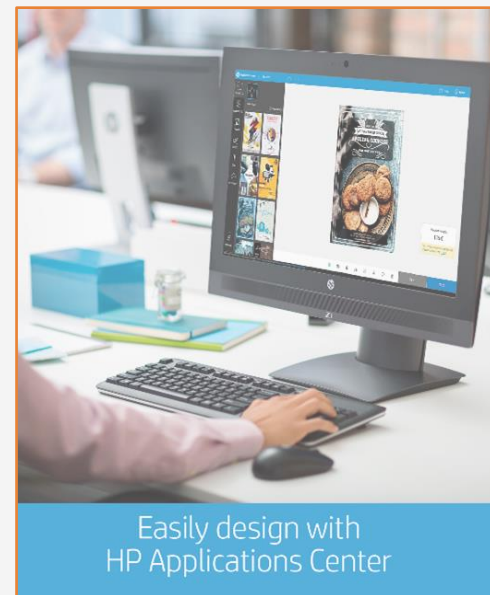

Easily design with HP Applications Center

#### How does it work?



##### 1. Join the platform

Simple, easy sign-in with your HP printer serial number.

##### 2. Choose a web app

Select the standalone decorative web apps you want to produce with and allow your customers to create and visualize the design with a simulation for each unique environment.

##### 3. Manage orders

Manage production efficiently with automatic, reliable, print-ready PDF generation, as well as customer, order, and content management tools.

**EXPAND YOUR KNOWLEDGE:** For further detailed information regarding HP Applications Center and how to log in for the first time, check out the [webinar](#) available at this [link!](#)

## 2. Job edition

One of the most common editing attributes is the **cutting path definition**.

- 1. Draw the cutting path:** it can follow the graphic's silhouette or can be a poster-like cut.
- 2. Create a new color swatch:** define it as a spot color and name it (e.g. CutContour, CutContourKiss, CutThrough...).
- 3. Assign** the color swatch for cutting to the cutting path.

**NOTE:** Normally, cutting paths are added in Adobe. HP Flexi Print and CUT RIP allows you to add them directly from the RIP. Please refer to the specific RIP manuals.

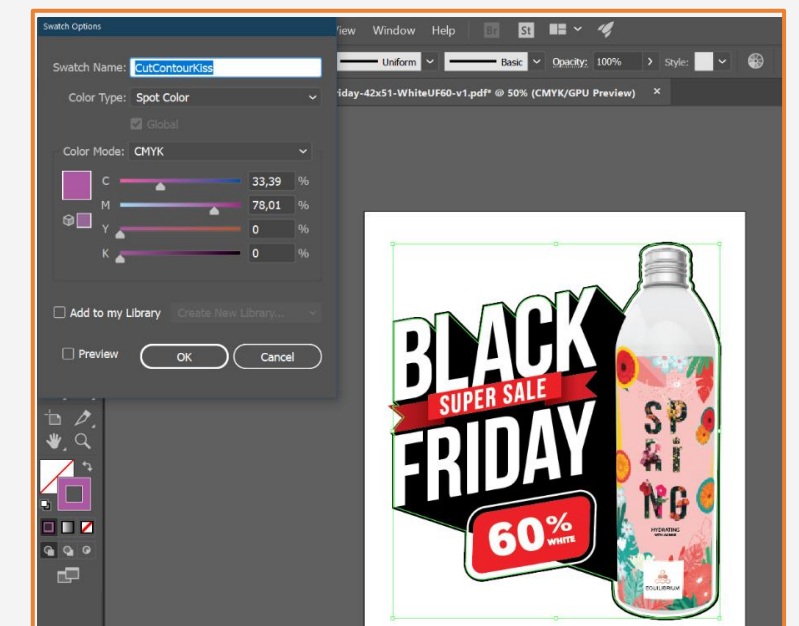

# How to create stickers

## Preparing the job

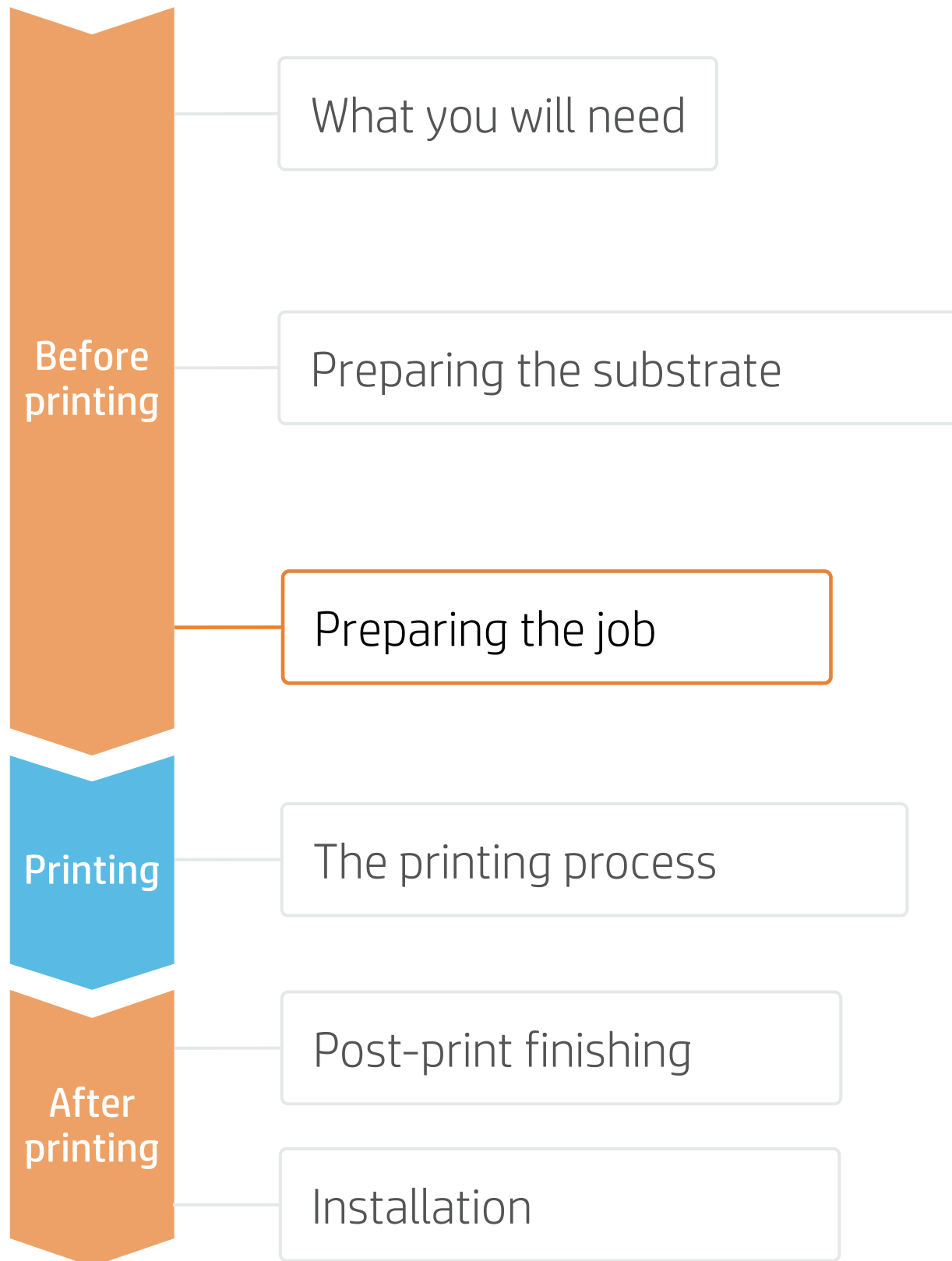

## A. Adding contour marks - With Adobe

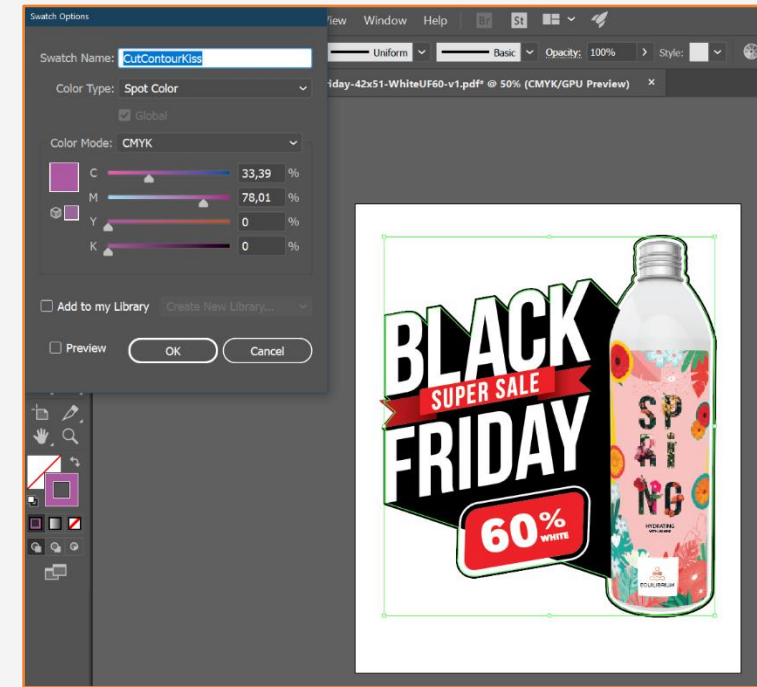

- Create a new color swatch
- Assign an identifiable name, e.g. CutContourKiss
- Select color type: Spot Color
- Create the cutting path with that color swatch

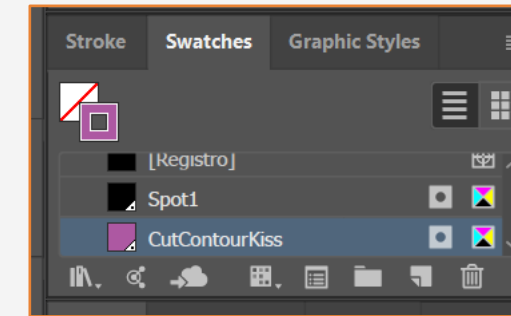

Make your decision based on your needs

## B. Adding contour marks - With SAI HP Flexi Print and Cut Editor

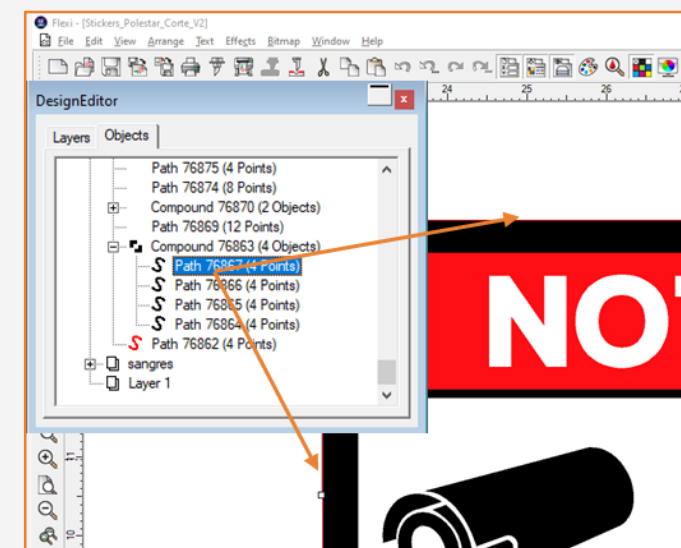

1. Select the path  
It will be highlighted in the Design Editor window

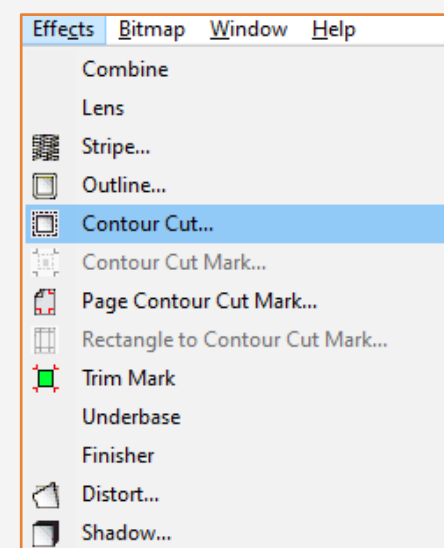

2. Add the Contour Cut  
From the Effects tab in the menu bar

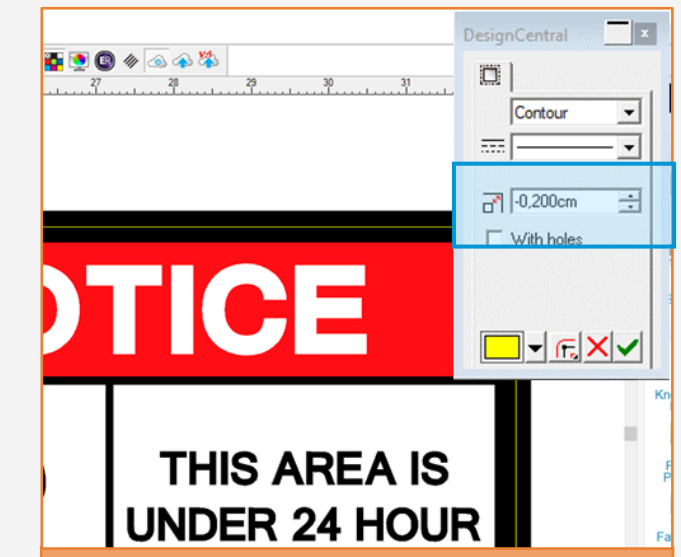

3. Specify Contour properties  
From the Design Central window.  
Select the color and click Apply ✓

**TIP:** To avoid cutting inaccuracies, add **bleed** to the contour line where the cutting path goes, so the cut will not fall in undesired areas

# How to create stickers

## Preparing the job

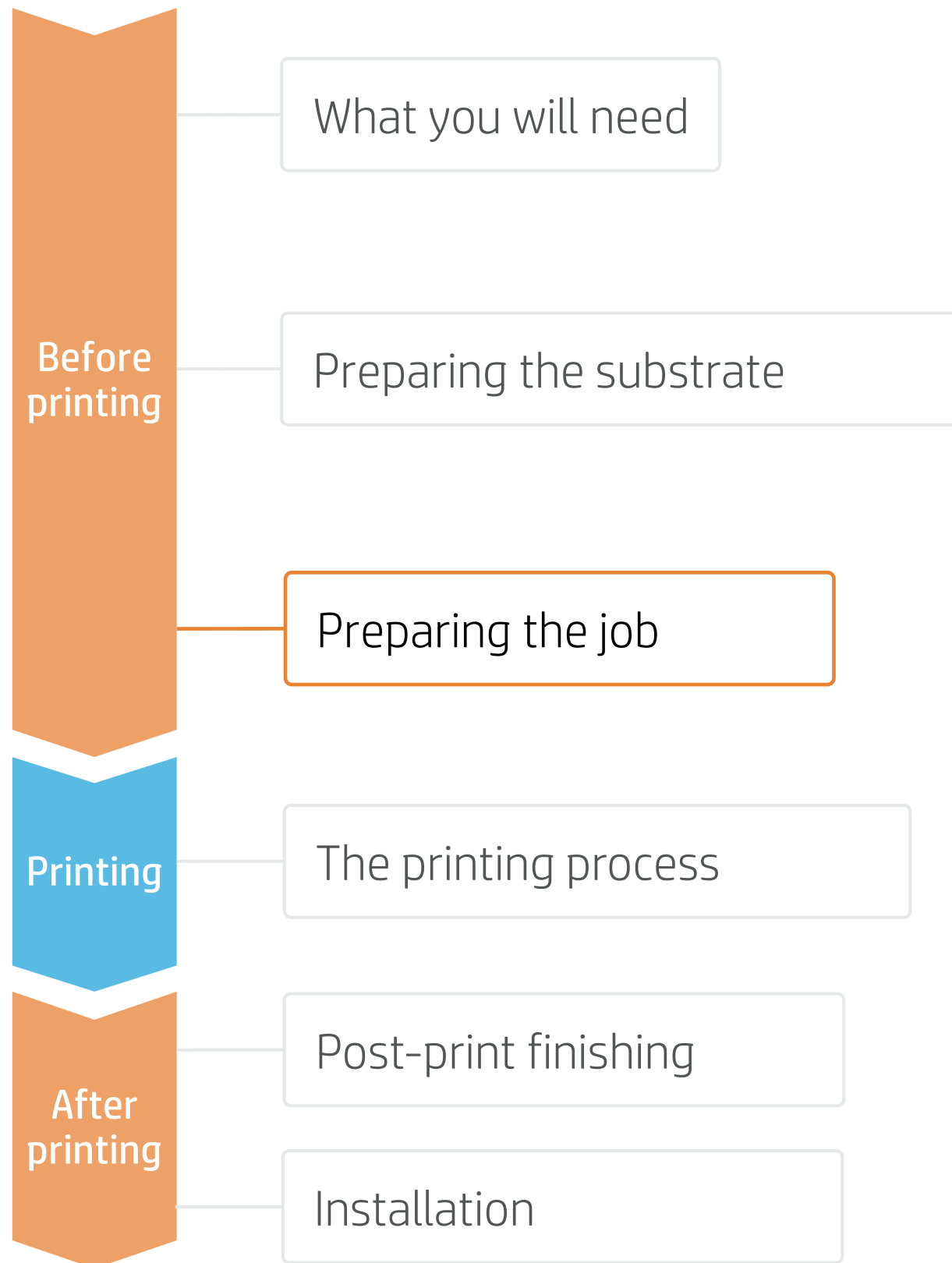

## 3. RIP processes

ONYX, Caldera, and SAi RIPs have been certified for HP Latex 700/800 series printers.

All these RIPs have specific options for job editing.



Make your decision based on your needs

### A. Substrate & Printmode selection

- Choose the substrate type (Self-adhesive vinyl), then select the specific substrate you have loaded on the printer.
- Next, choose the printmode. Normally, **6p mode** gives good quality prints with SAV. For higher IQ, choose **8p mode**.
- If graphics are going to be **laminated**, activate the **optimize for lamination** option in your RIP or select a printmode with Overcoat at Odpp.

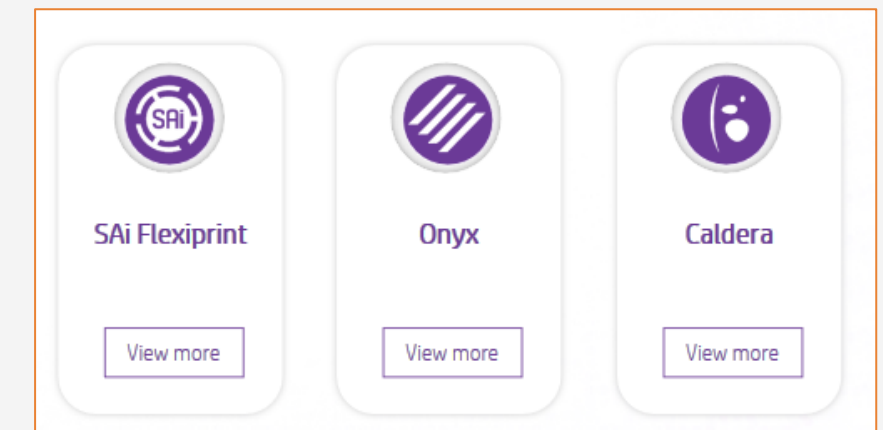

**NOTE:** Please refer to the specific trainings on RIPs at the PrintOS Learn app.

### B. Image size & copies

- Select the image for your sticker.
- Modify the image size
- Set the number of copies

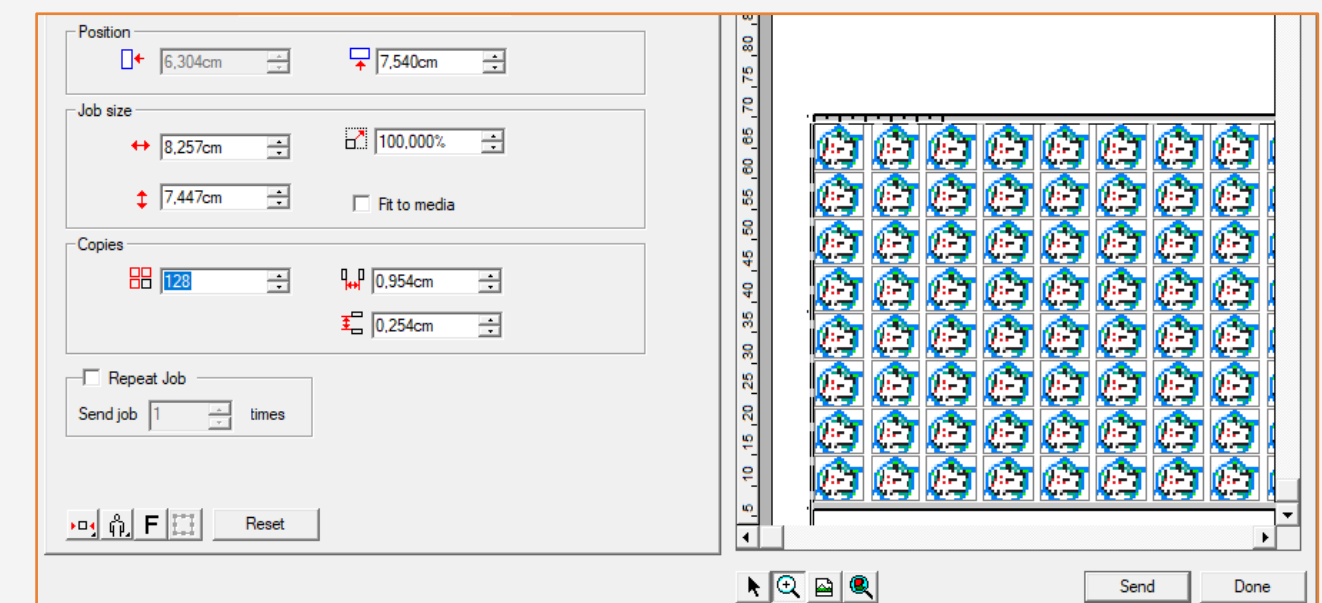

**NOTE:** To work with white ink layers, learn how to create one with Illustrator and Photoshop by enrolling in the available training: "HP Latex 700/800 Printer series - White ink" on the [Learn with HP website](#), or refer to the cookbook [How to print on white](#).

# How to create stickers

## Preparing the job

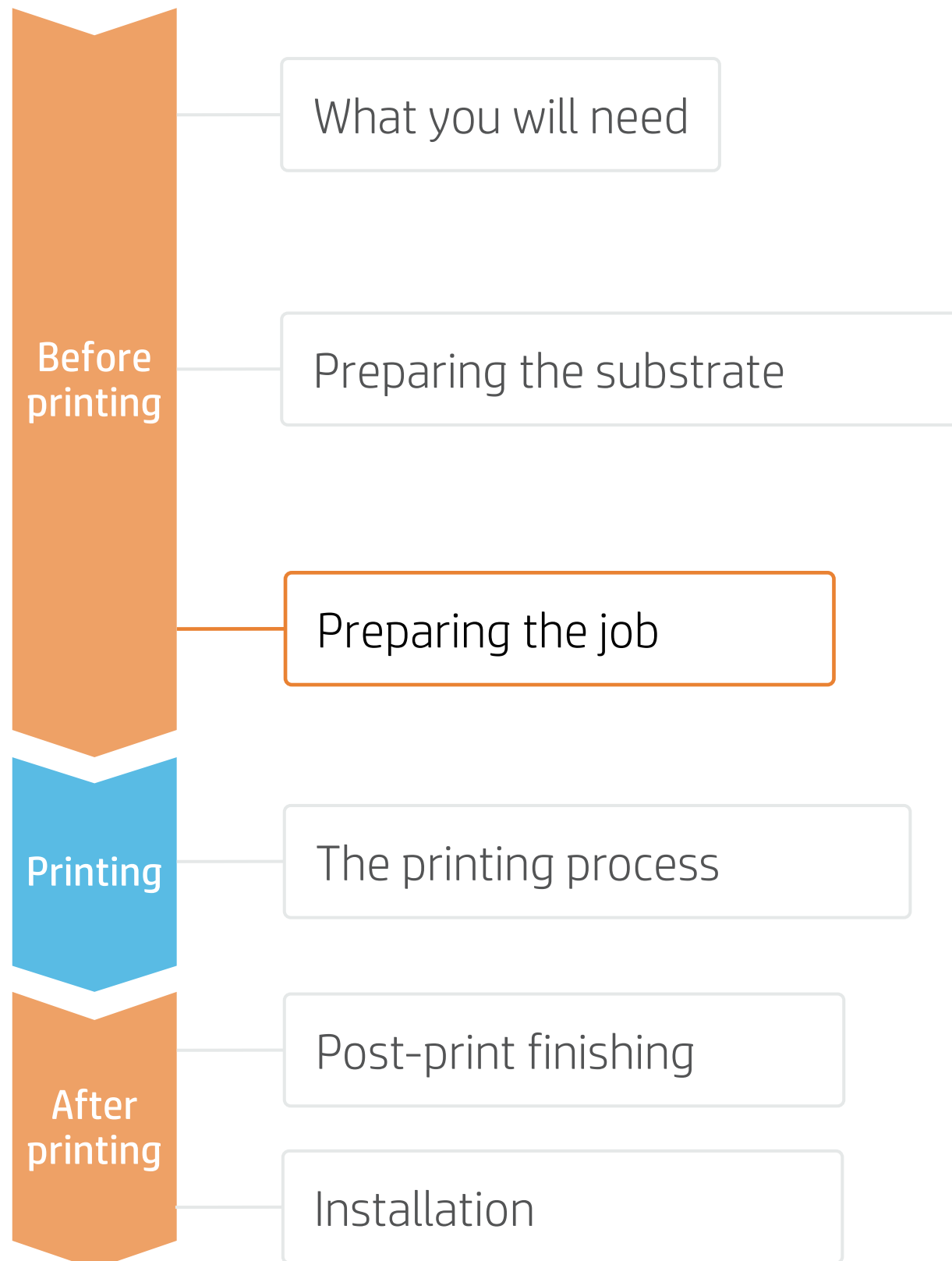

## C. Option to optimize lamination



Make your decision based on your needs

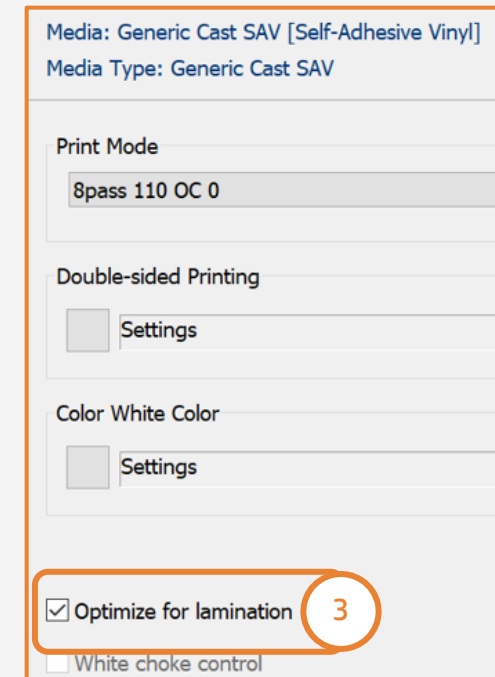

### ONYX

In the job queue:

1. Right-click on your job.
2. Select **Edit - Printer Settings**.
3. Click **Optimize for lamination**.

### Caldera

1. Open your printer options menu.
2. Click on **Specific settings for printer** (wrench icon).
3. Under the **Advanced parameters** menu, select **Optimized for lamination**.

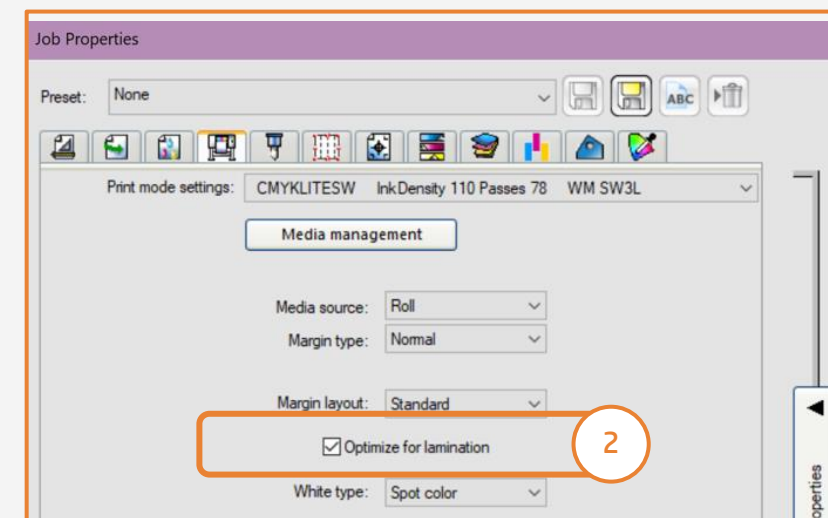
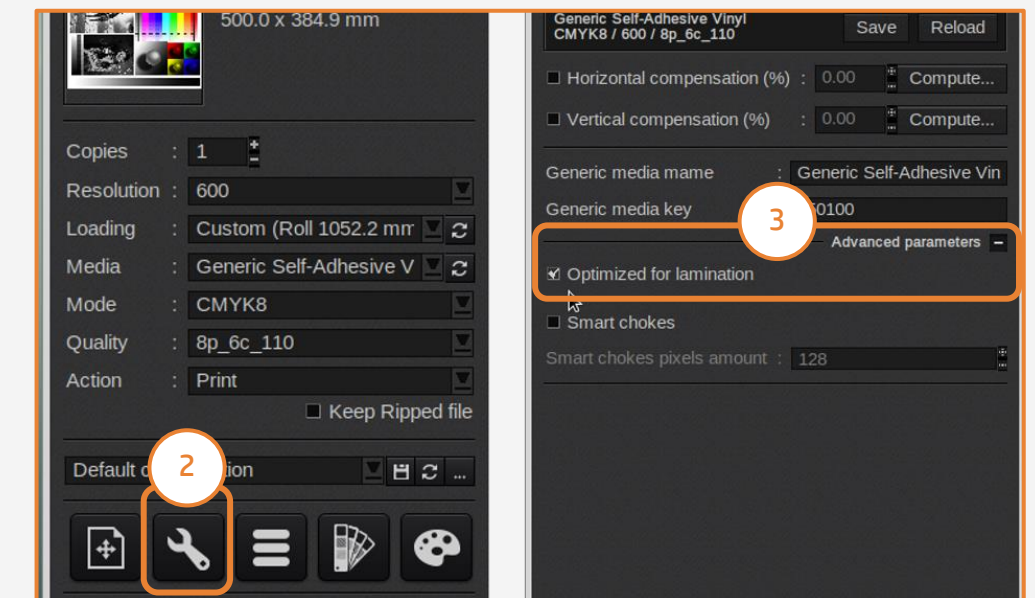

### SAi

In the job properties menu:

1. Select the **Printer Options** tab.
2. Select **Optimize for lamination**.

# How to create stickers

## Preparing the job

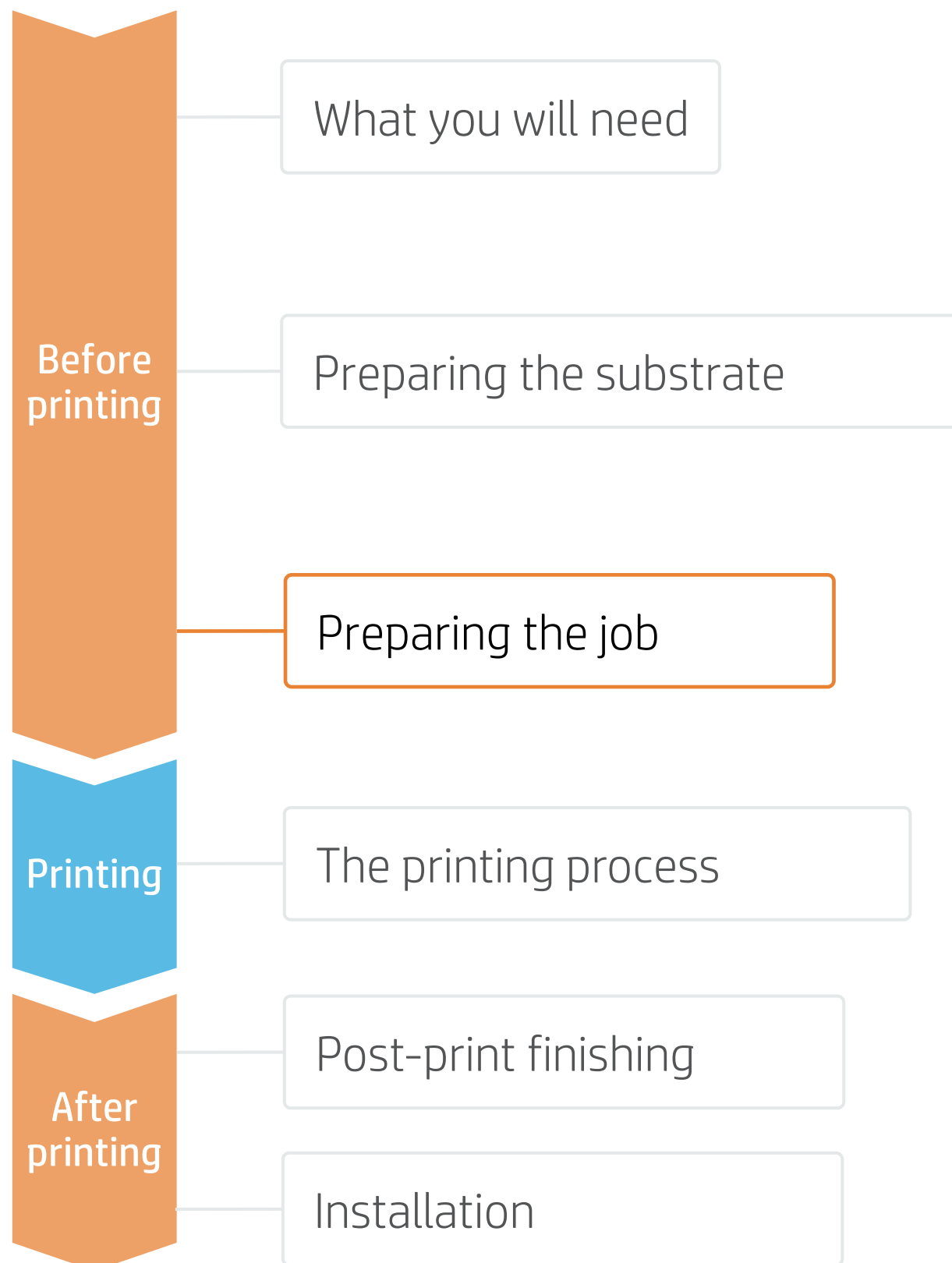

### D. Registration marks and the HP barcode

Registration marks ensure the right cutting accuracy and correct compensation. The HP barcode enables unattended cutting, with automatic job retrieval direct from the new HP Latex Cutting Plus Solutions.

- Select the OPOS option that better suits your job.

**OPOS** – A row of marks is printed on the left and right sides of the graphic. Used to correct skew when there is no deformation on the print.



**OPOS XY** – Registration marks and a horizontal line are printed for deformation correction. The OPOS sensor reads the bottom line to correct for the deformation.



**OPOS XY2** - Registration marks and a horizontal line are printed for deformation correction. The OPOS sensor reads the bottom line to correct for the deformation, if any.



**OPOS XY2** - Registration marks and multiple horizontal lines are printed for deformation correction. The OPOS sensor reads the horizontal lines by panels to correct for deformation.



- Add the HP barcode for an automatic workflow.

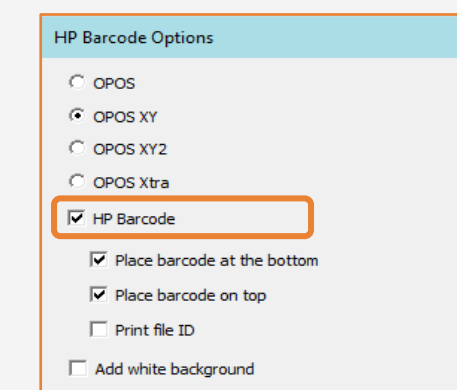
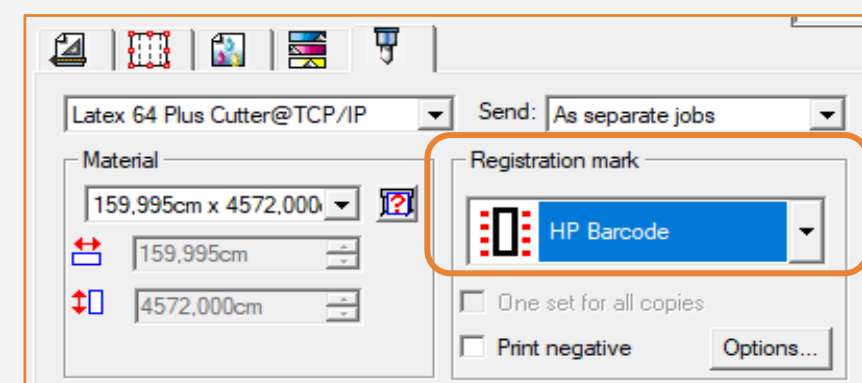

**NOTE:** Find more information on HP cutting solutions at the following link:

- [hplatexknowledgecenter.com/printers](https://hplatexknowledgecenter.com/printers)
- [HP Latex Plus Cutter - User Guide](#)



# How to create stickers

## Preparing the job

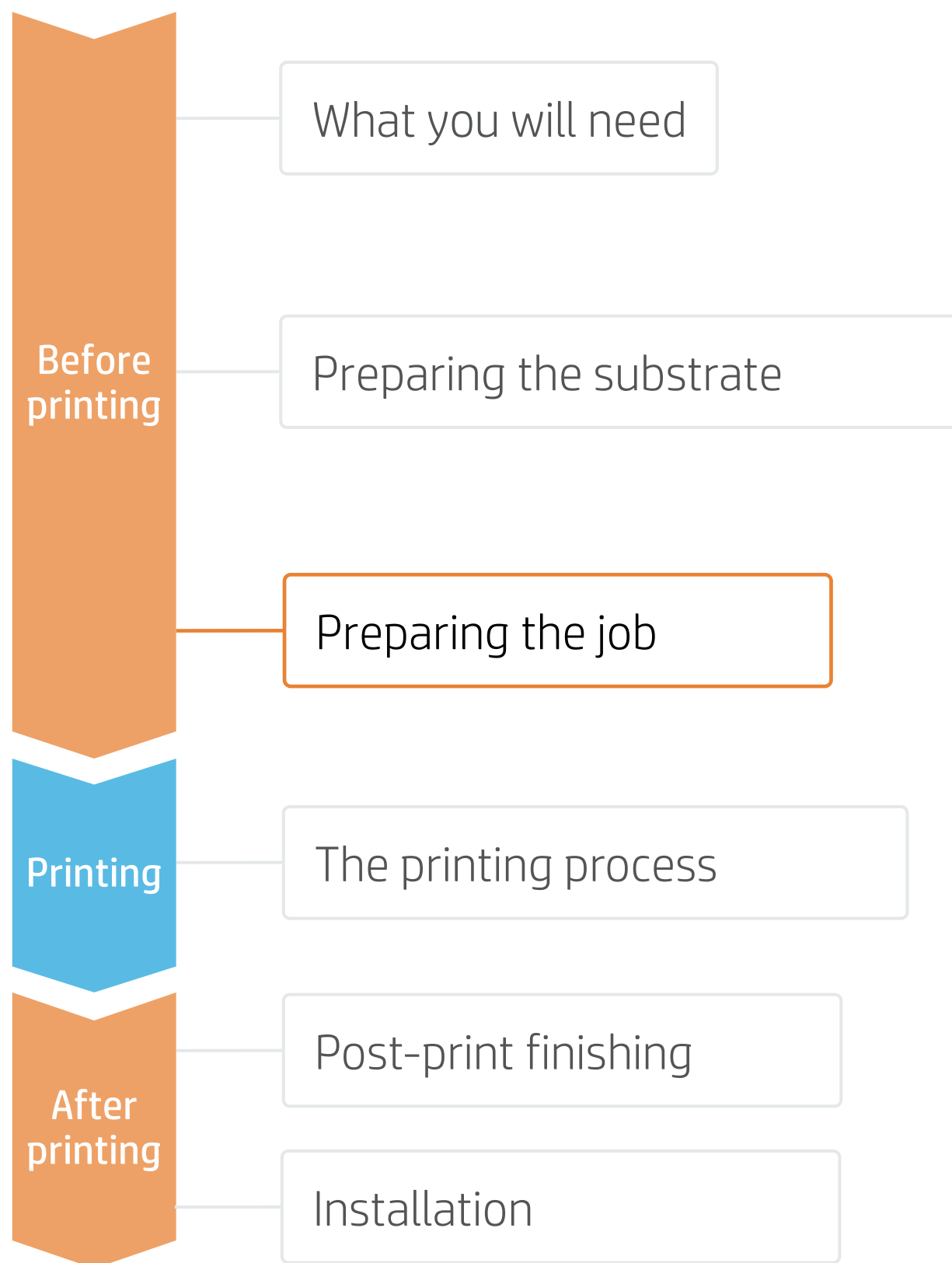

## E. Cutting parameters

The most common parameters to adjust for the cutter are the cutting **pressure** and the cutting **speed**.

Cutting parameters need to be **adjusted for each cut type** that is present in your cutting job.

- Kiss cut cutting path
- Cut through cutting path (optional)

1. Set the **default** cutting parameters in the RIP

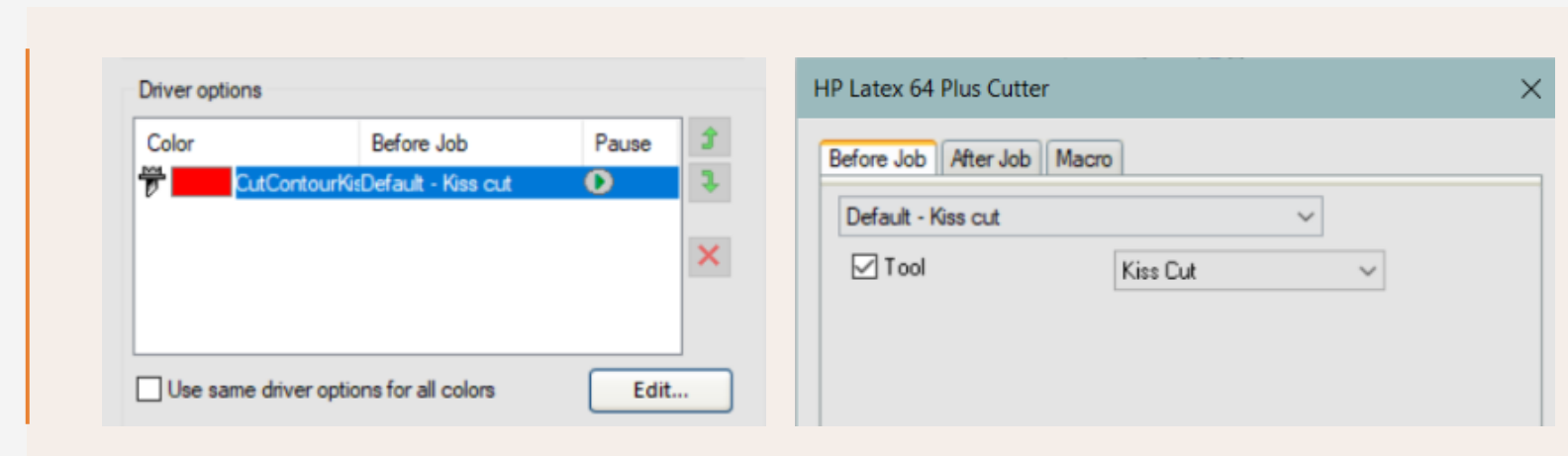

2. Before cutting your job, adjust **pressure** and **speed** from your cutter's settings menu

**HP Cutter** Configuration 1  
LAN 192.168.10.2

50000 x 145 mm

Knife

700 mm/s

90 g

Kiss cut

Test

**TIP:** The knife pressure is set correctly when the test pattern cuts completely through the vinyl, the vinyl is removed, and the blade tip has visibly scratched the front side of the substrate backing (liner). The blade should never cut through the backing.

**HP Cutter** Configuration 1  
LAN 192.168.10.2

50000 x 145 mm

Knife

700 mm/s

90 g

**FlexCut**

Full pressure

Full pressure cut length

Flex pressure

Flex pressure cut length

FlexCut mode

FlexCut Velocity

Cut through (FlexCut)

Test

**TIP:** The setting is correct when the substrate is cut completely through but the test pattern stays together, so it can later be torn out.

# How to create stickers

## Preparing the job

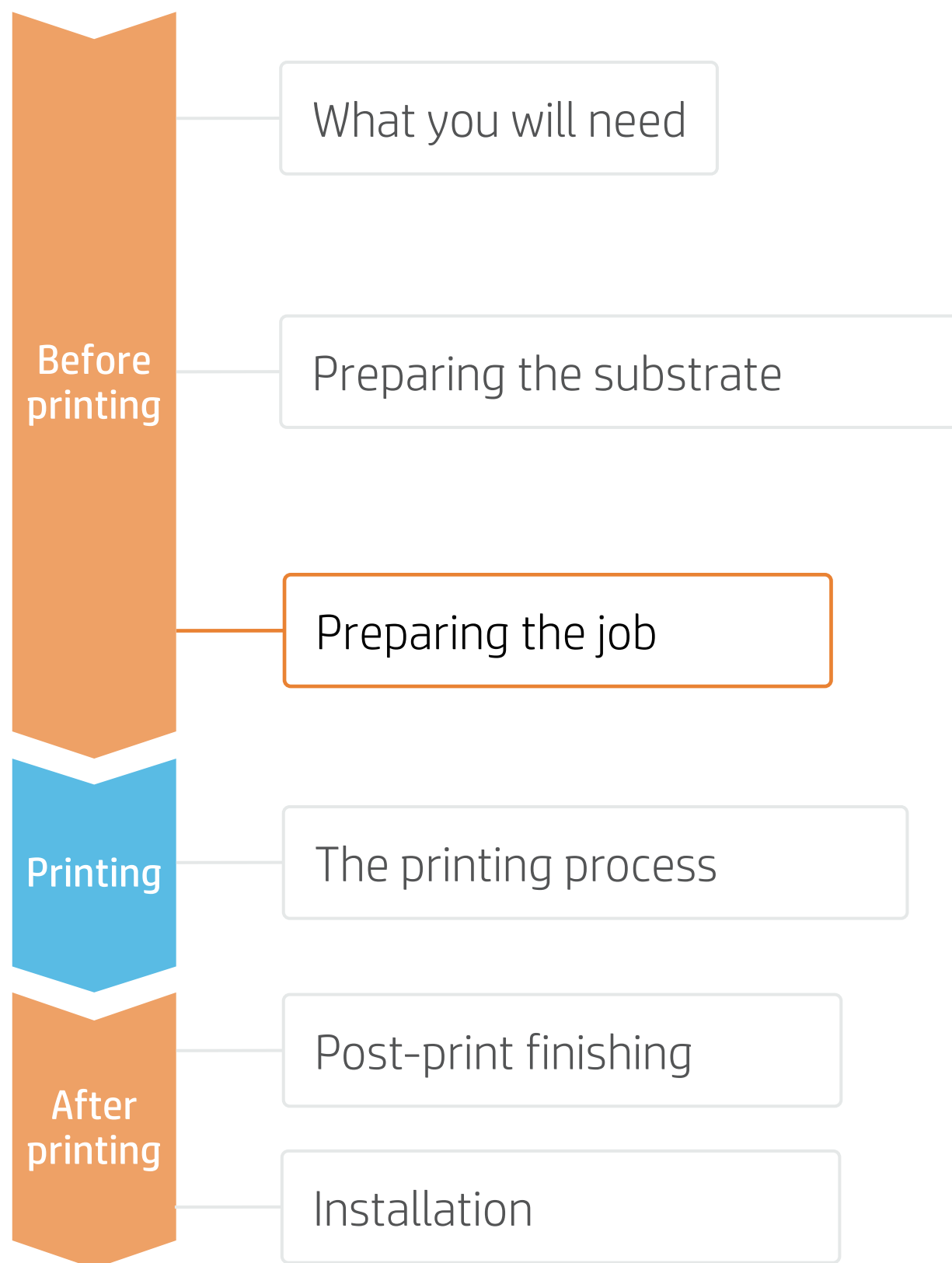

## 4. Tips for print&cut jobs with white ink on special substrates - SAI

Some specific settings are required to work with substrates such as:

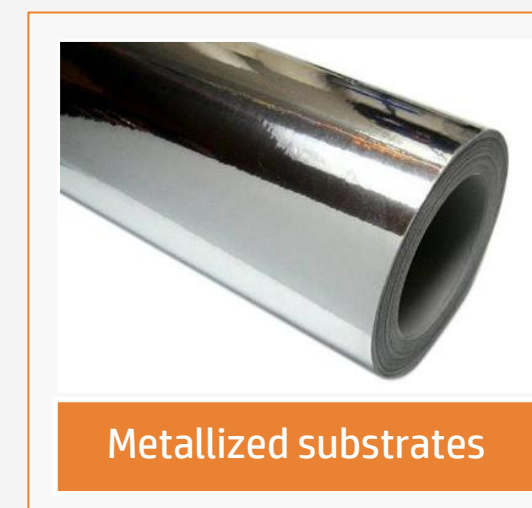

### A. Select printmodes

- Select a white printmode: UF, SP, OF or SW of W100 density

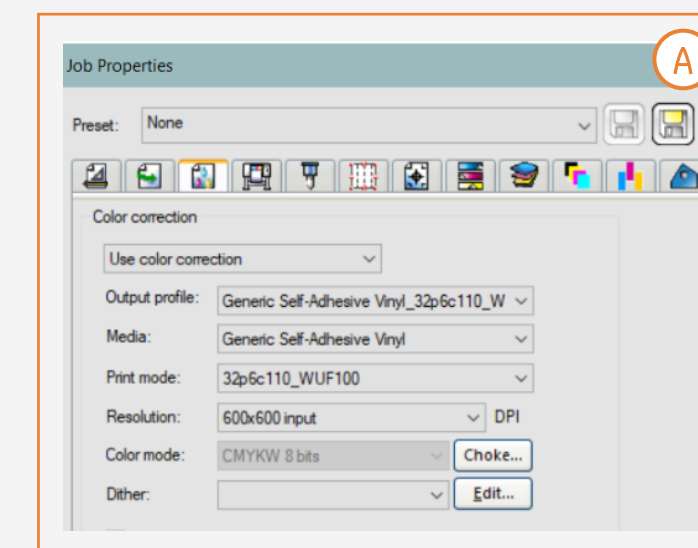

### B. Color separation

- Select Channel Spot1
- Edit
- Select Print as White

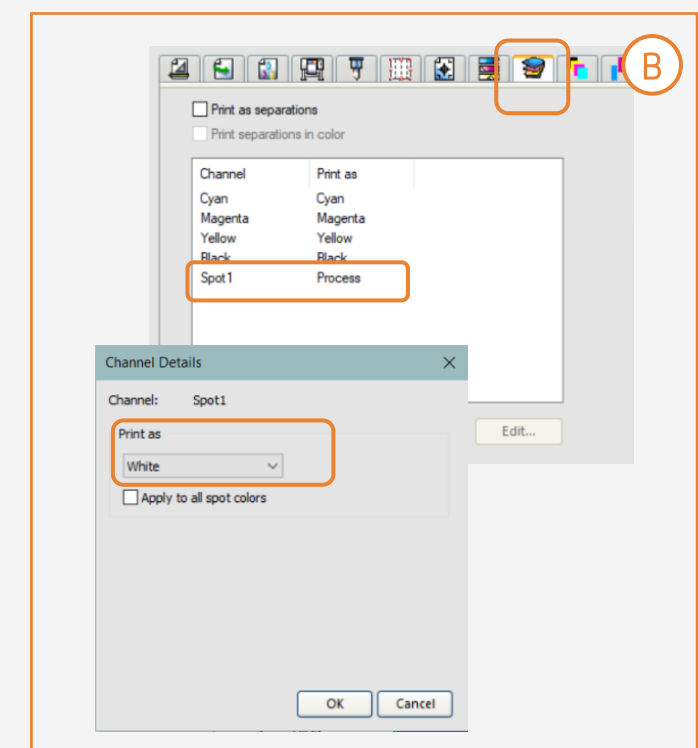

### C. HP barcode

- Select the OPOS desired and HP barcode
- Select "Add white background". See picture (C1)
- OPOS and HP barcode are printed with white borders so they can be read by the OPOS sensor. See picture (C2)

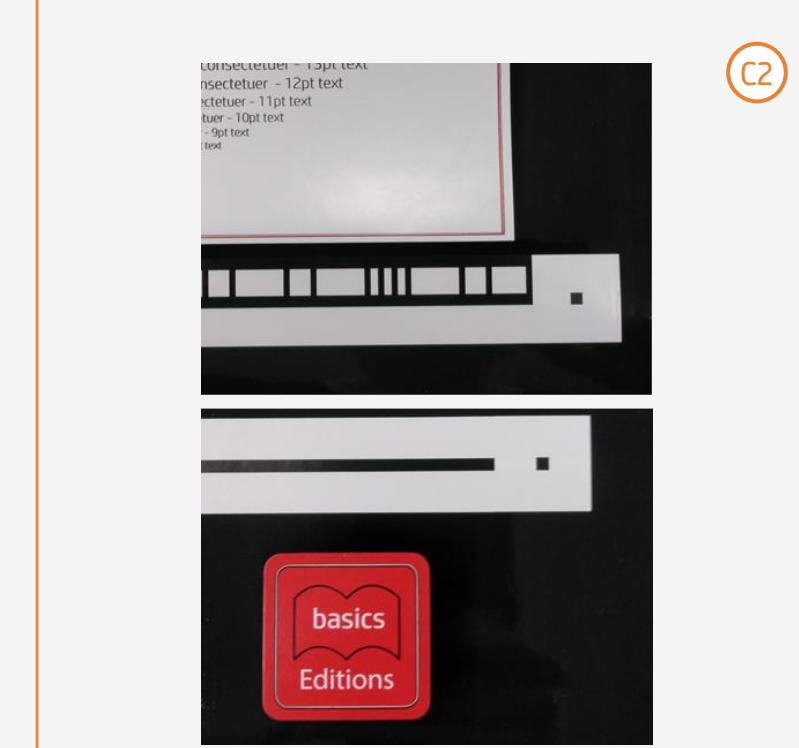
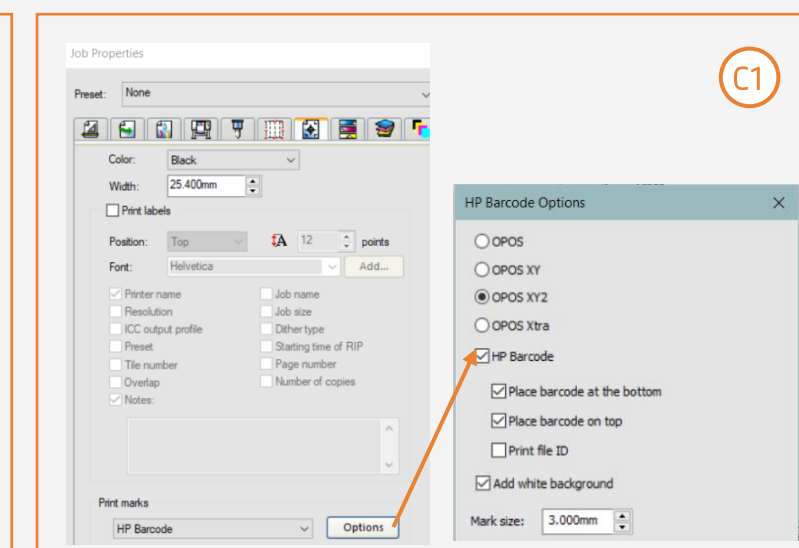

# How to create stickers

## Preparing the job

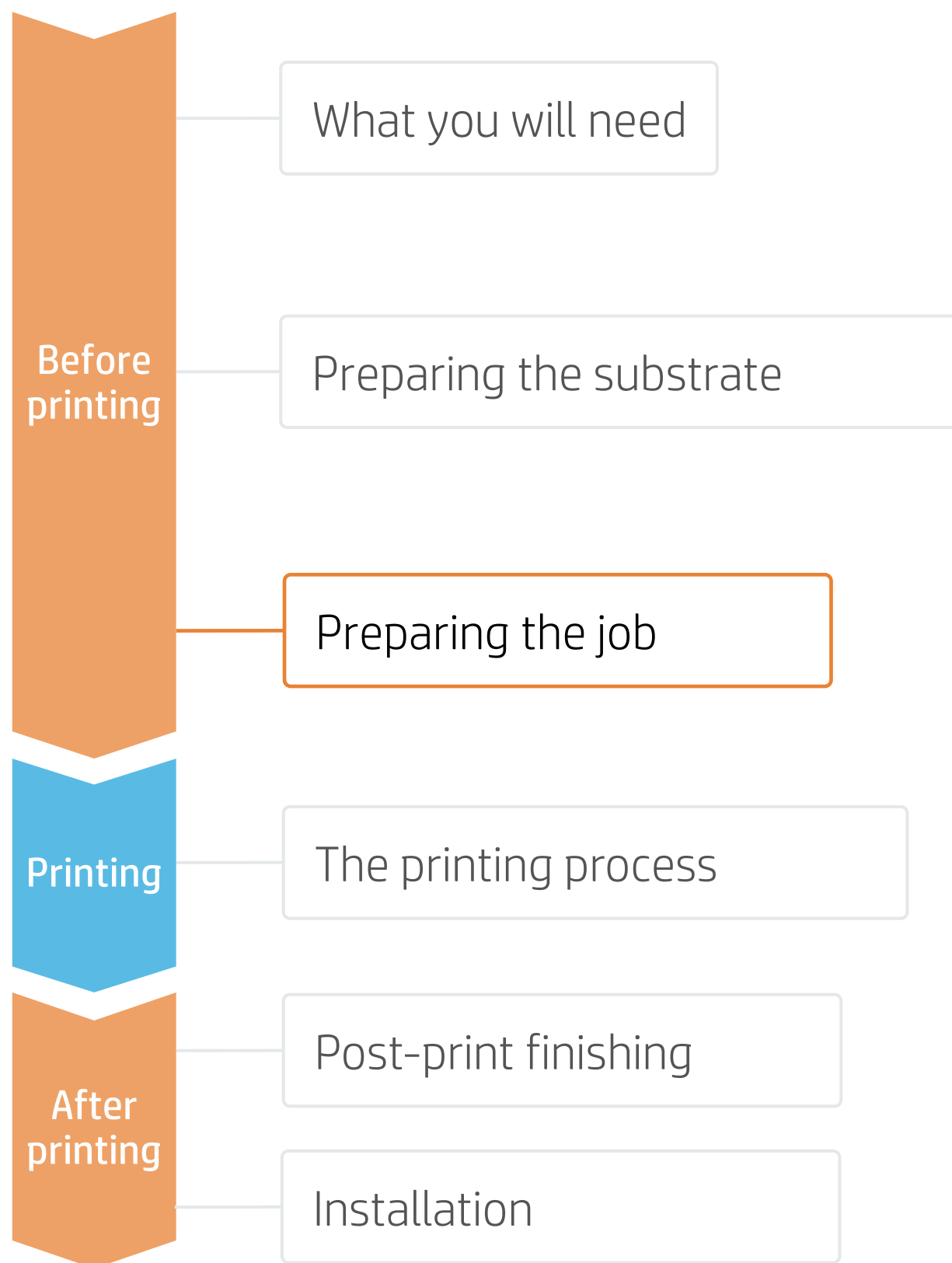

## 5. Metallized effects with white ink | using metallic finish substrates, SAI & ColorLogic

Thanks to HP Latex white ink, ColorLogic software, and a metallic finish substrate such as KernowJet Metalik Inkjet, you can get metallized effects.

© Color-Logic Inc www.color-logic.com

**COLOR LOGIC** Special Effects for Print™

**KERNOW COATINGS LTD**

### Create

Create your image files with metallized effects with Adobe and the **ColorLogic** palettes and **plug-ins**. For more information, check the ColorLogic website <https://www.color-logic.com/>.

### A. Load image file

- Load your pdf file.
- Right-click on it to open the Job properties menu.

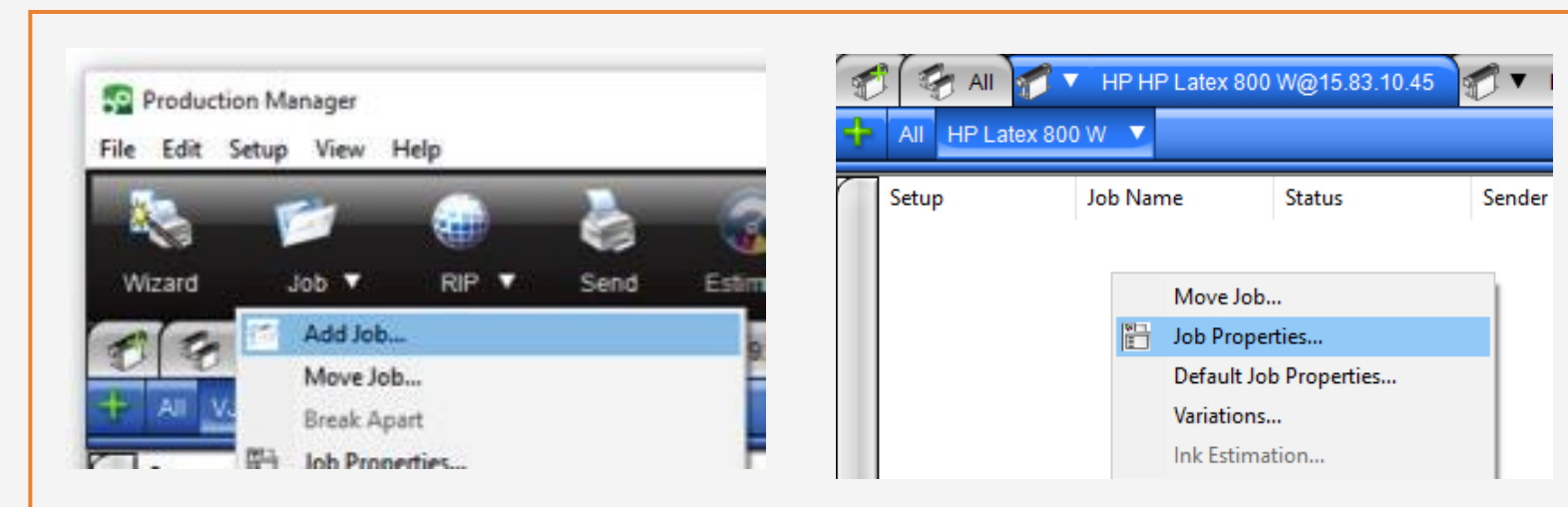

# How to create stickers

## Preparing the job

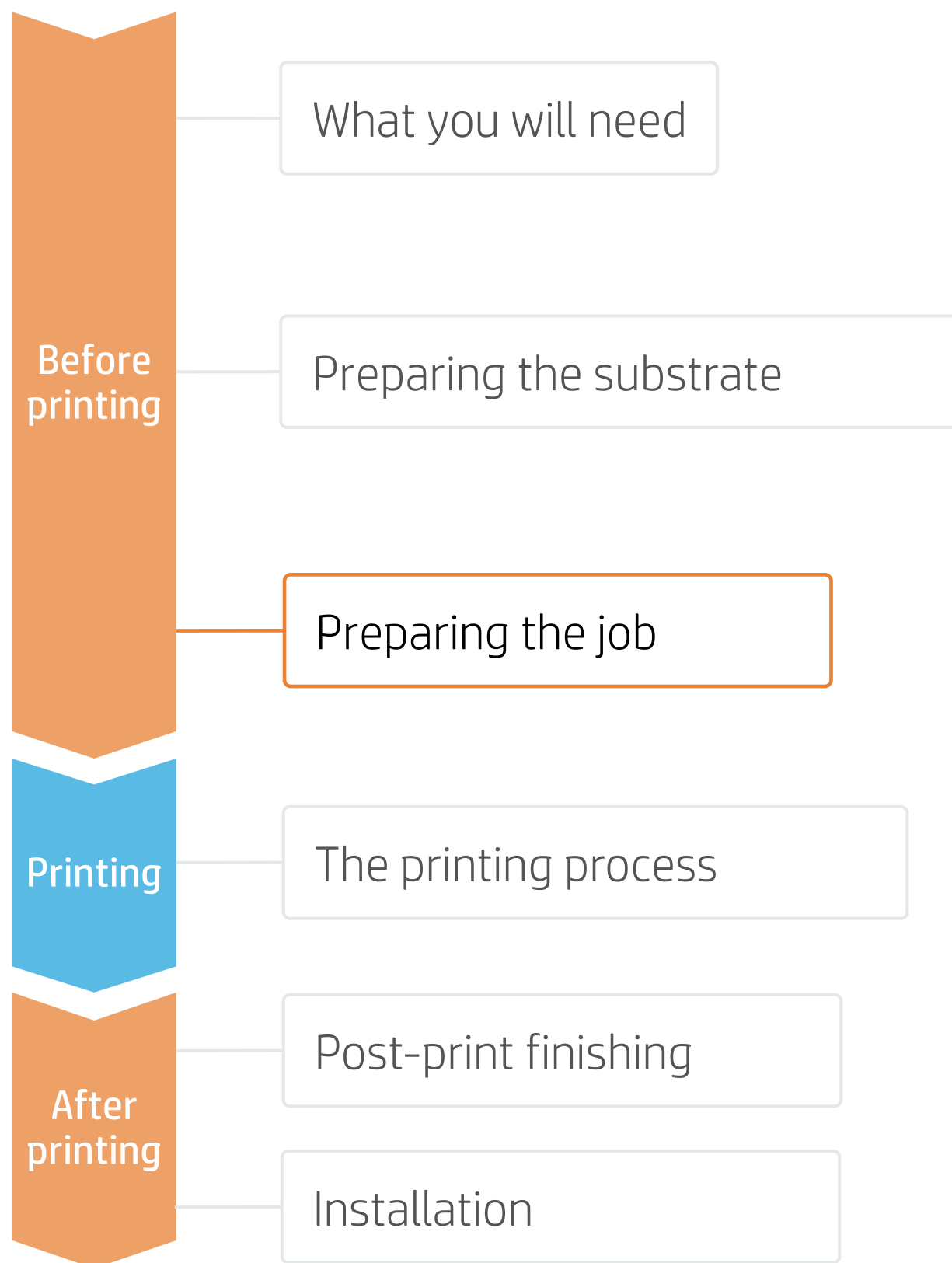

### B. Color correction

- Click the **Color management** tab and select **Use linearization only**.

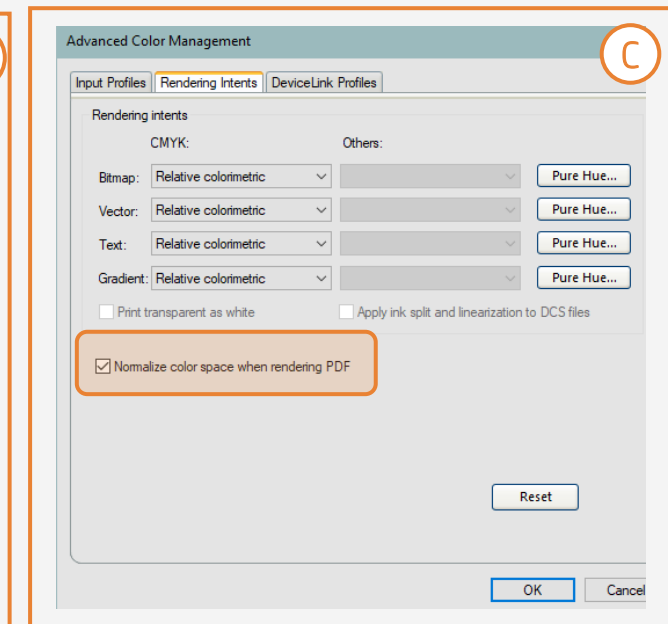
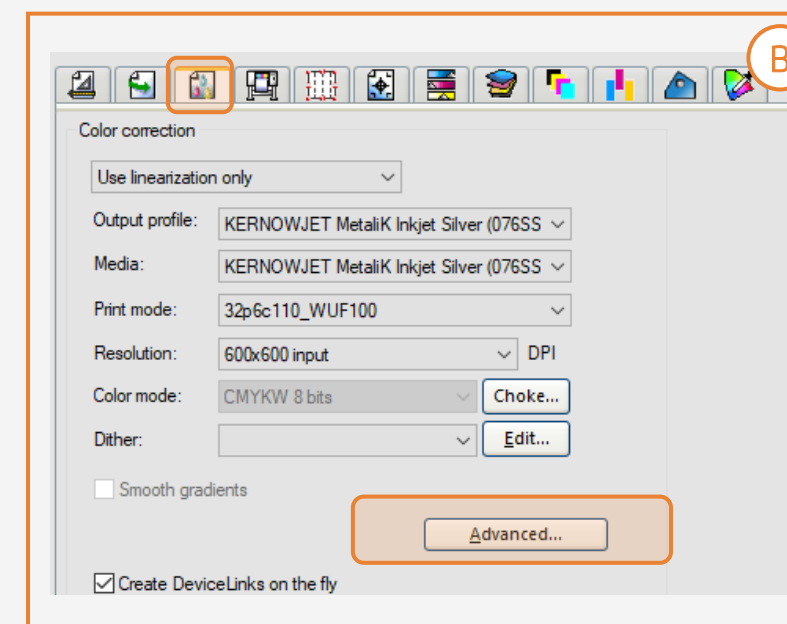

### C. Rendering intents

- Click on **Advanced** to set the rendering intents and tick **Normalize color space when rendering PDF**.

### D. Color separation

- Click the **Separations** tab, select the **CL 4713 SILVER** channel and click **Edit**

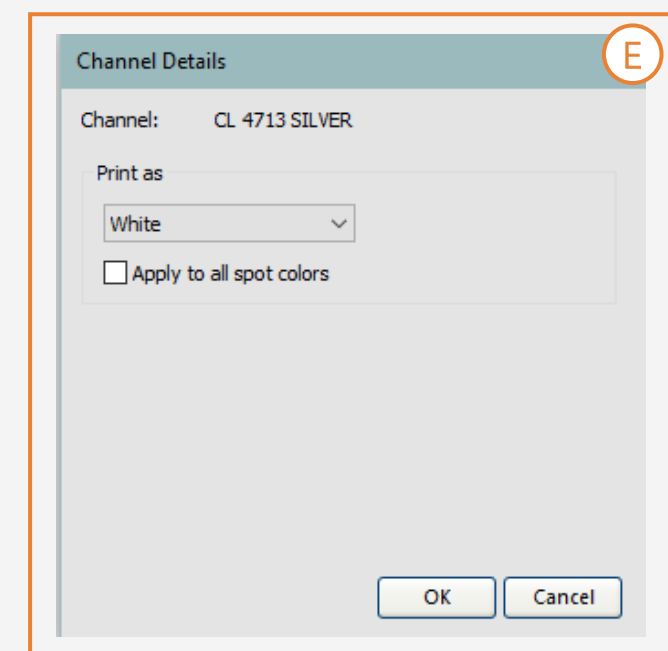
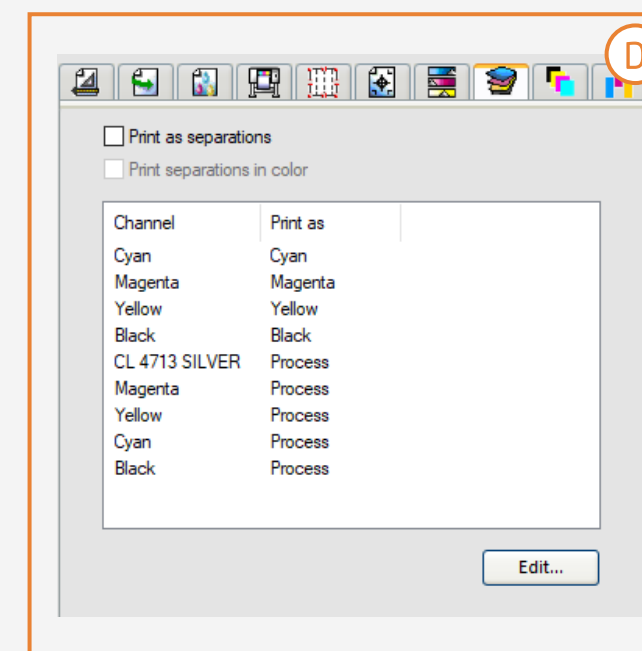

### E. White channel

- Change **Print as** to **White**

### F. Inverting channel

- Go to the **Color Adjustments** tab and select the **White** channel.
- At the bottom of the graph, click on the **#0**, and enter **100%** in the **Output** text box.
- Then click on the **#100**, and enter **0%** in the **Output** text box.

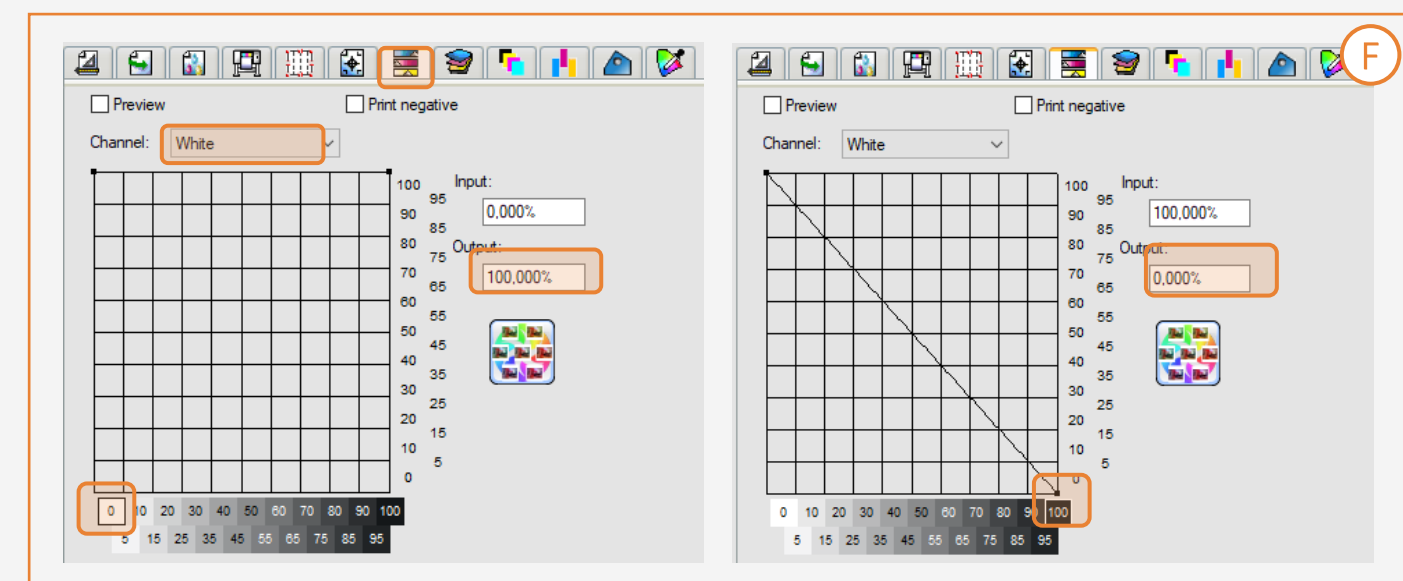

# How to create stickers

## The printing process

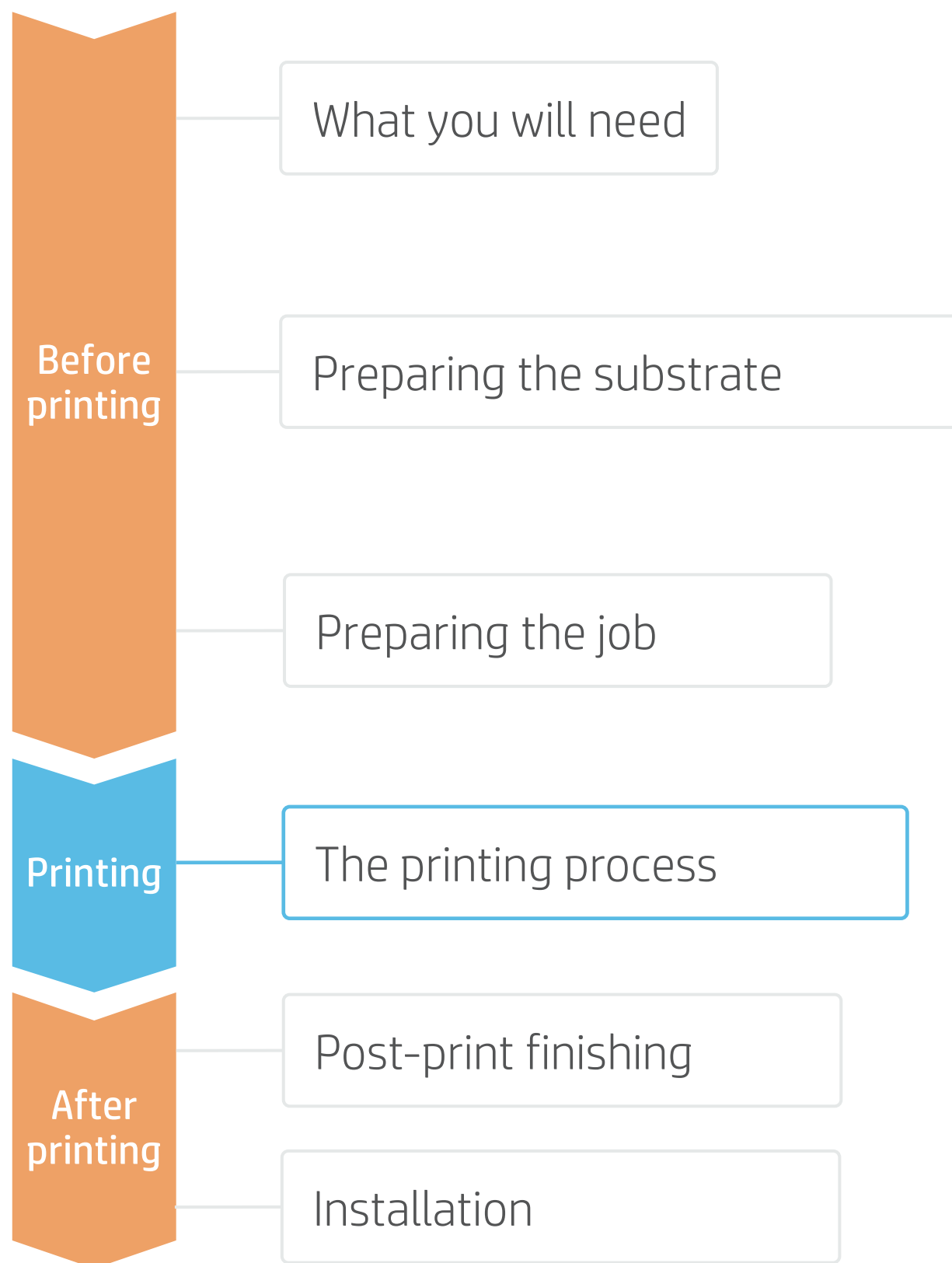

## Loading substrate | Connecting to the take-up reel (TUR)

- 1. Prepare the TUR**
  - Attach an empty core on the TUR.
- 2. Move substrate**
  - Advance substrate until the leading edge levels with the TUR.
- 3. Release substrate from pinches**
  - Lift the pinchwheels.
  - Align the right edge of the substrate with the right edge of the input roll.
  - Tap **Done** in the front panel to lower the pinchwheels.
- 4. Attach substrate to the TUR (optional)**
  - You can attach the substrate so that the printed side is **in (a)** or **out (b)** (out is the most common).
- 5. Activate the TUR**
  - Complete a full rotation of the TUR.
- 6. Calibrate the TUR**
  - Select **Calibrate** on the front panel.

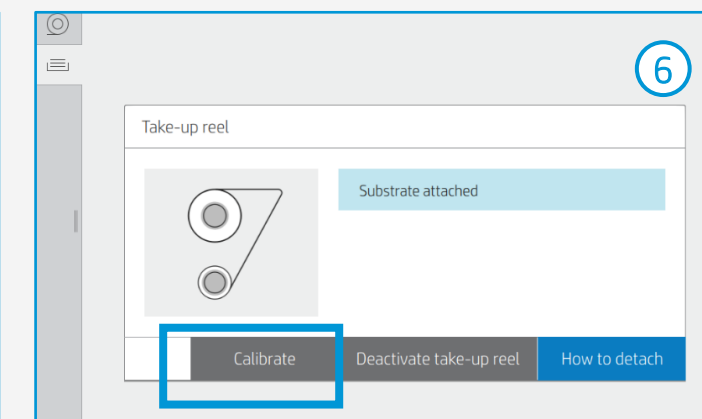
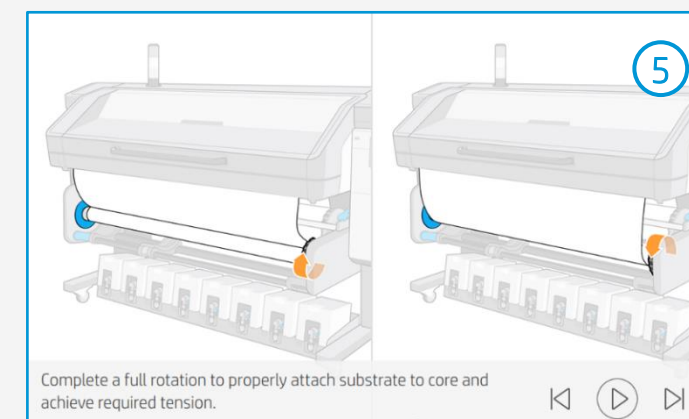
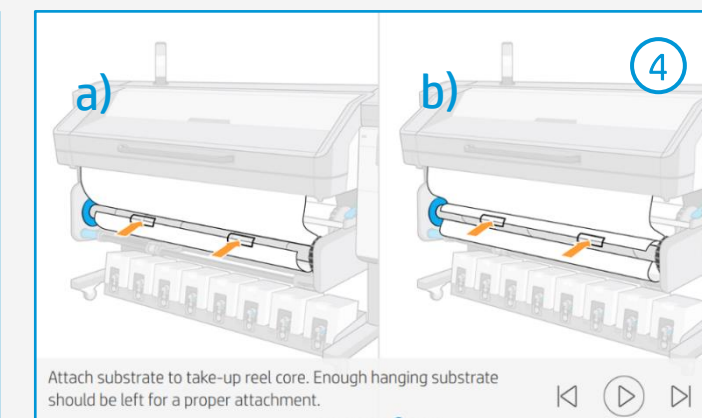
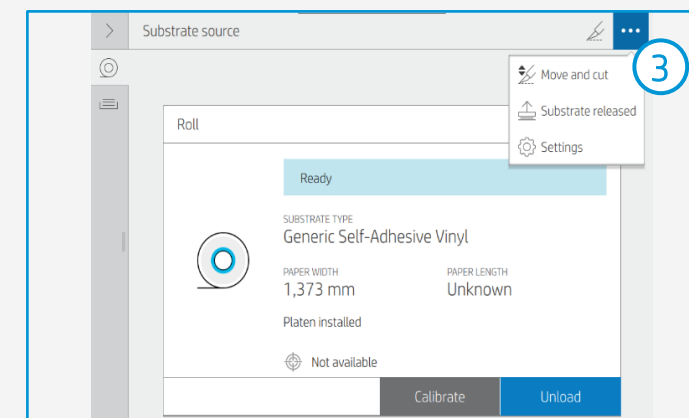
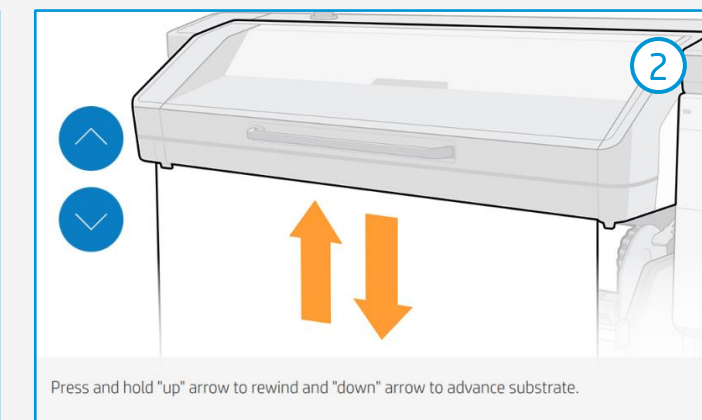
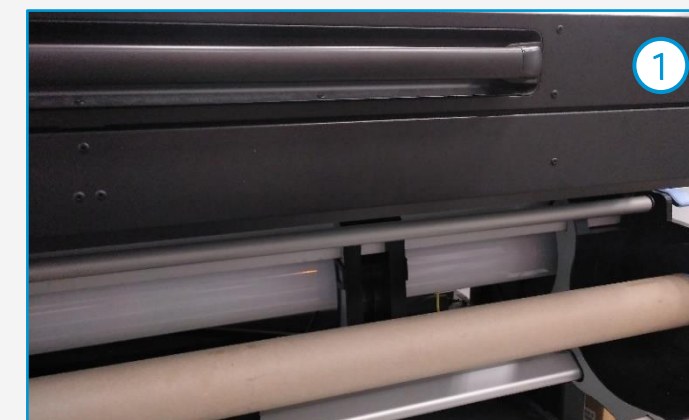

**TIP:** For long jobs, connect the substrate to the take-up-reel (TUR). For tiling applications, connect the TUR before starting to print.

# How to create stickers

## The printing process

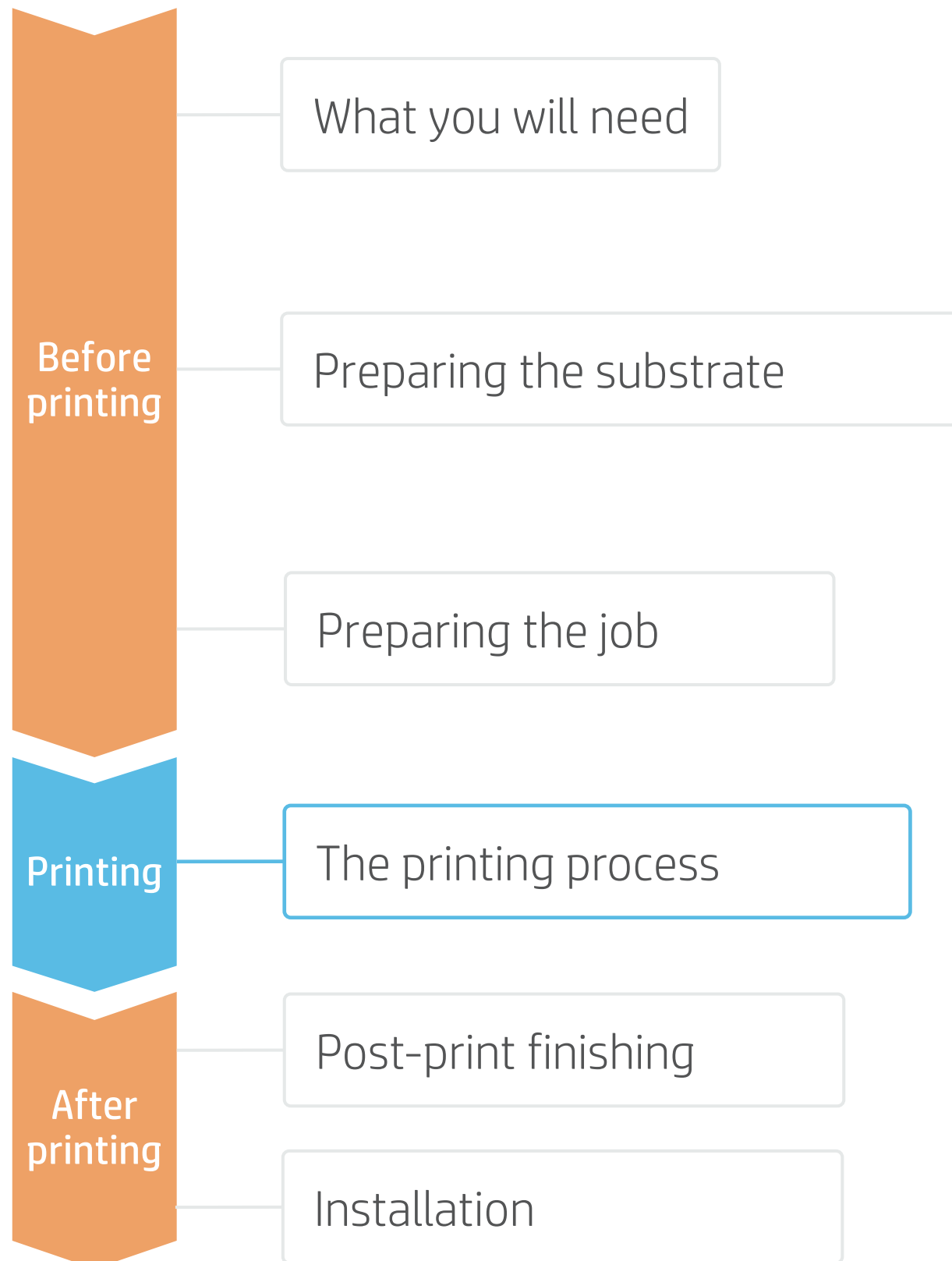

- 1. Load the roll**  
By default, this is in automatic mode.
- 2. Select the right substrate preset**  
If your substrate is new, select the **Generic self-adhesive vinyl** preset.
- 3. Check print IQ status**  
Perform the Printhead nozzle check and Printhead alignment.
- 4. Start printing position**  
Normally this is from the printing platen, but some vinyls may need to be positioned after the curing zone or even be attached to the TUR to avoid a substrate crash.
- 5. Send the job to print from the RIP**
  - Check that the RIP has **synchronized** the loaded substrate with the printer.
  - Select the correct printmode and any other settings (copies, placements, etc.)
  - Click **Send to print**.
- 6. Cut & retrieve the printed roll**  
This can be done in automatic mode or manually.

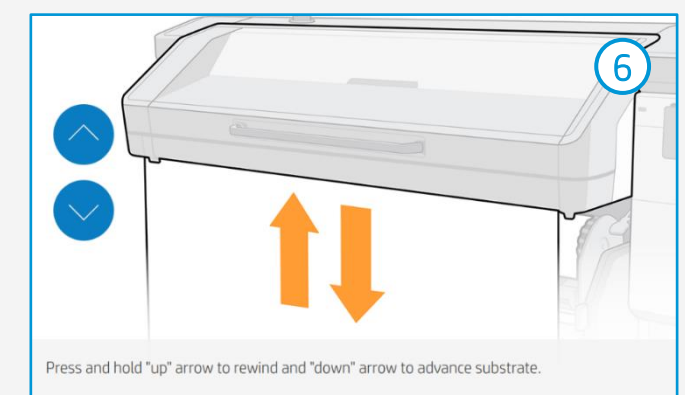
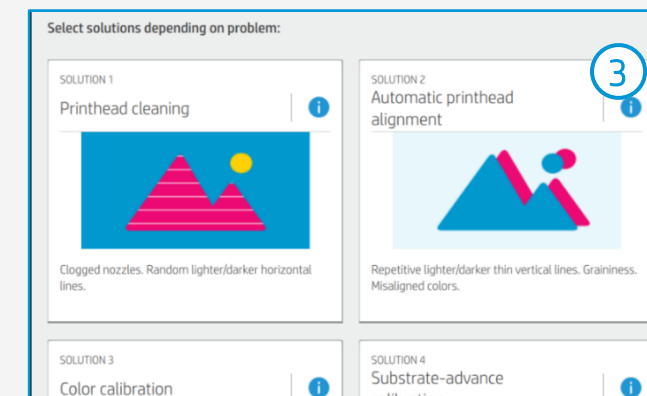
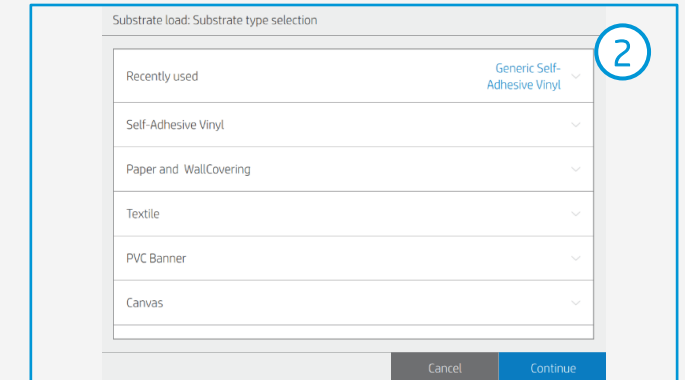
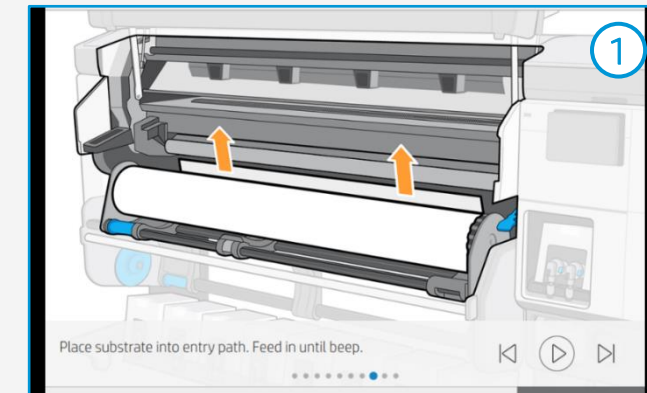

**TIP:** Before cutting the printed job, advance the substrate so that you protect the printed roll when it is unloaded.

# How to create stickers

## Post-print finishing

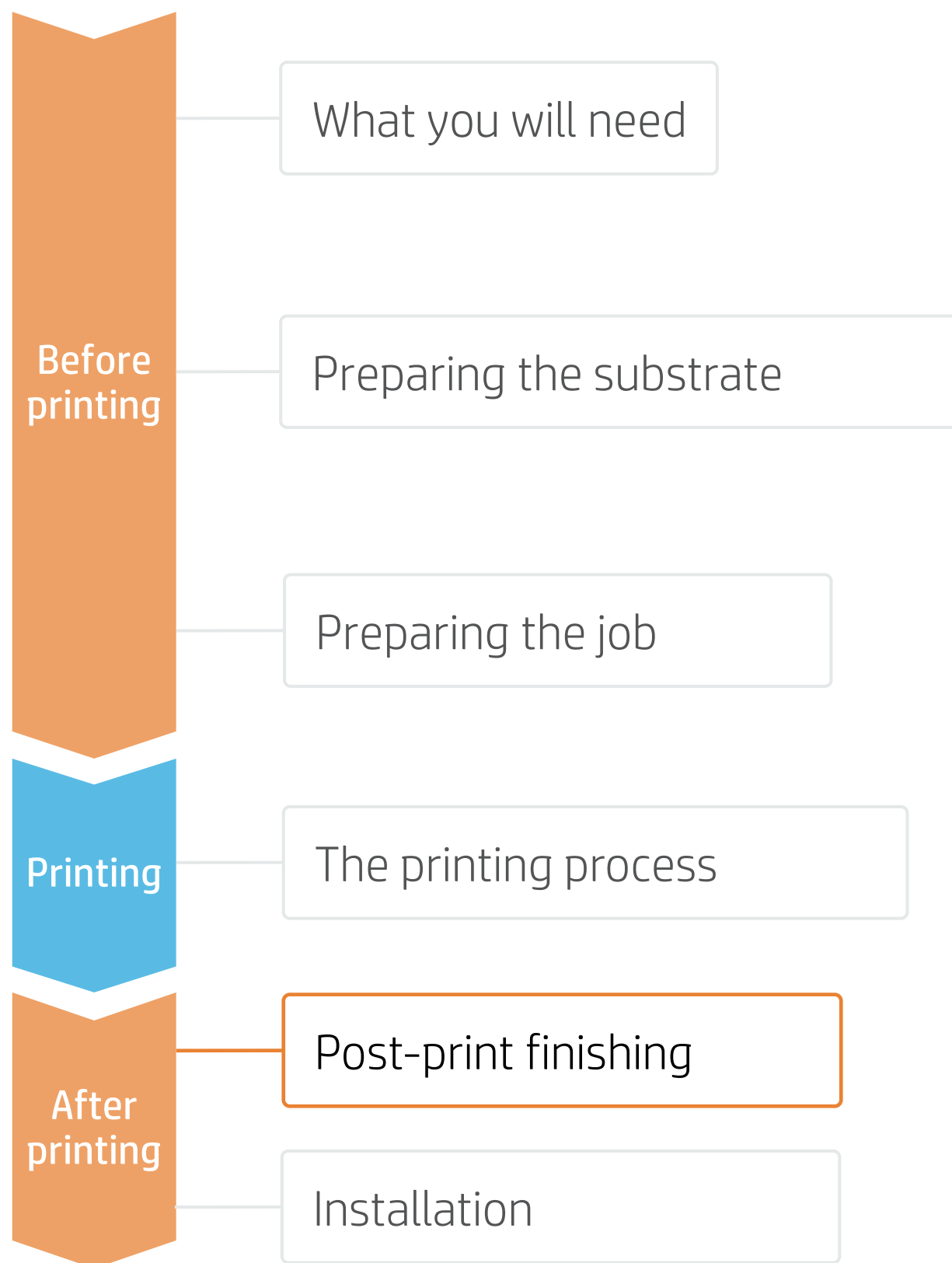

### 1. Lamination (optional)

Use the film laminate recommended by the SAV manufacturer.

Follow the lamination settings (speed, pressure, and temperature) specific for the SAV+laminate combination.



**⚠ IMPORTANT!:** Recommended for long-term usage, high-transit areas, and surfaces that will be cleaned frequently.

**💡 TIP:** Remember to select a printmode with NO overcoat when laminating, or check the option “Optimize for lamination” in the RIP’s printer settings.

### 2. Cut

To cut the graphics automatically, you can use XY cutters or flatbed contour cutters.

“Kiss cut” cutting type will be the most common, but on some occasions, a “cut through” can be added to separate each sticker.



New HP Latex Cutter Plus



Weeding after a kiss cut



Sticker with cut through

# How to create stickers

## Post-print finishing

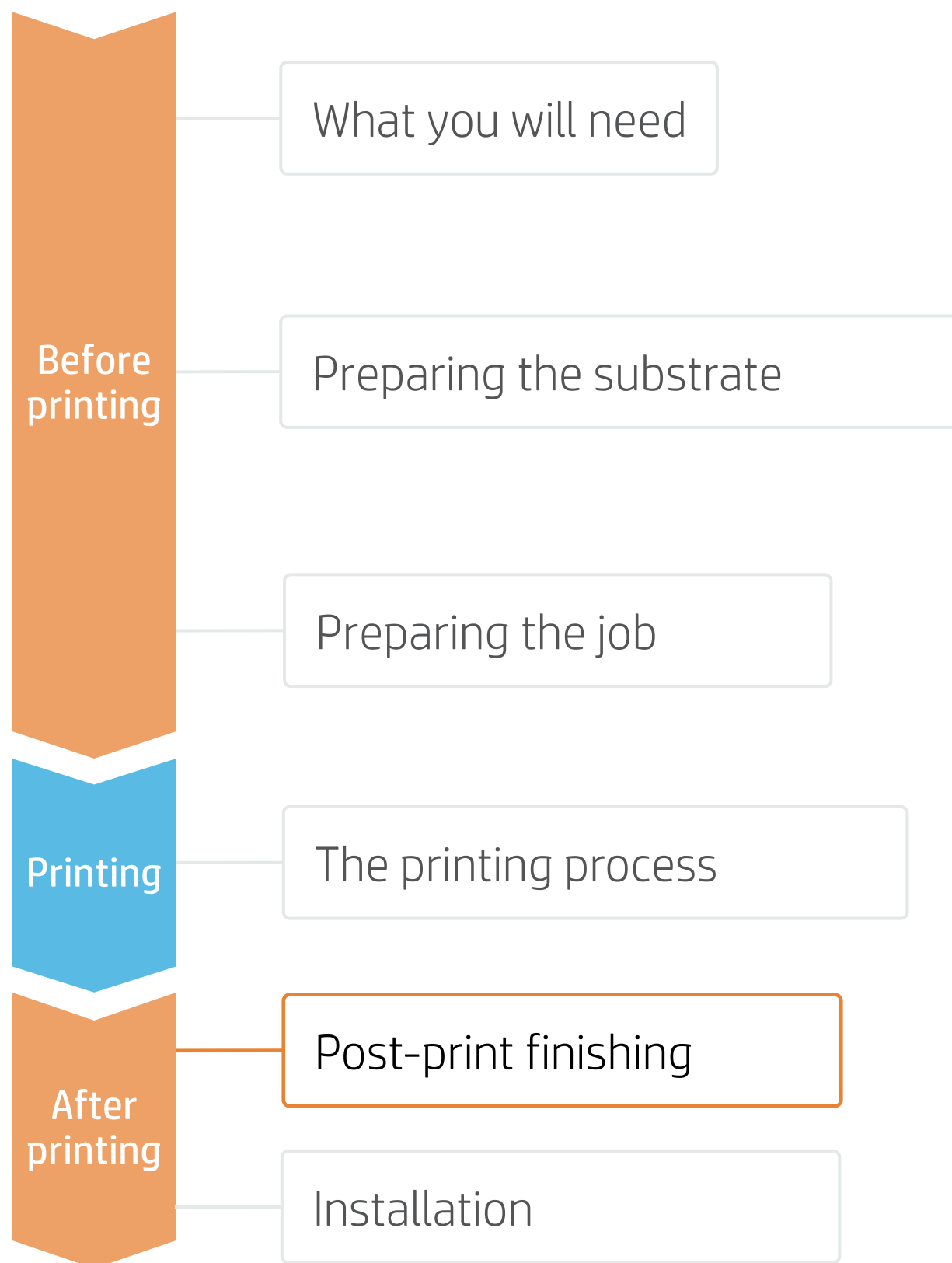

### 3. Cutting special medias – white ink OPOS

#### A. Load the plot correctly



Position the plot so that the first pinch partly rolls over the white part of the HP barcode (see picture).

#### B. Calibrate media (OPOS)



Print calibration boxes (3x3 cm) in black (100 CMYK) and white (Spot W100) on the substrate for your print&cut jobs.

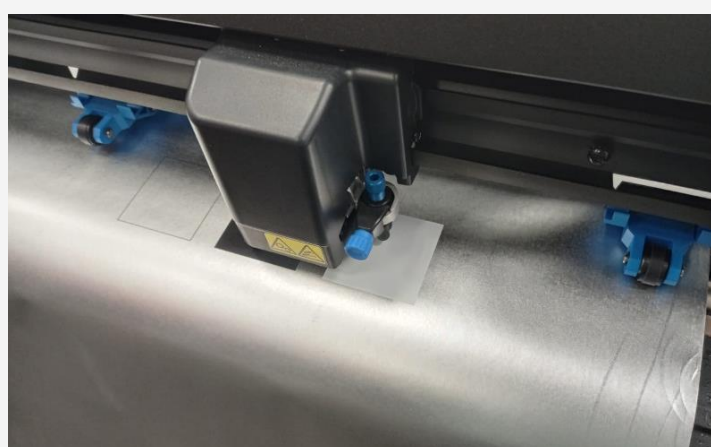

On the cutter's front panel, tap: **Calibrations > Calibrate media (OPOS)**. Follow the front panel instructions; you will be asked to position the OPOS sensor above each color patch, including the non-printed area.

**⚠ IMPORTANT!:** The unattended workflow will not work with the HP barcode with a white background. After the first job is cut, you will have to position the OPOS sensor just below the HP barcode of the next job.

**💡 TIP:** Perform all the necessary calibrations on your cutter before continuing with your print&cut job. For further information, check the HP Cutter [user guide](#).



# How to create stickers

## Installation

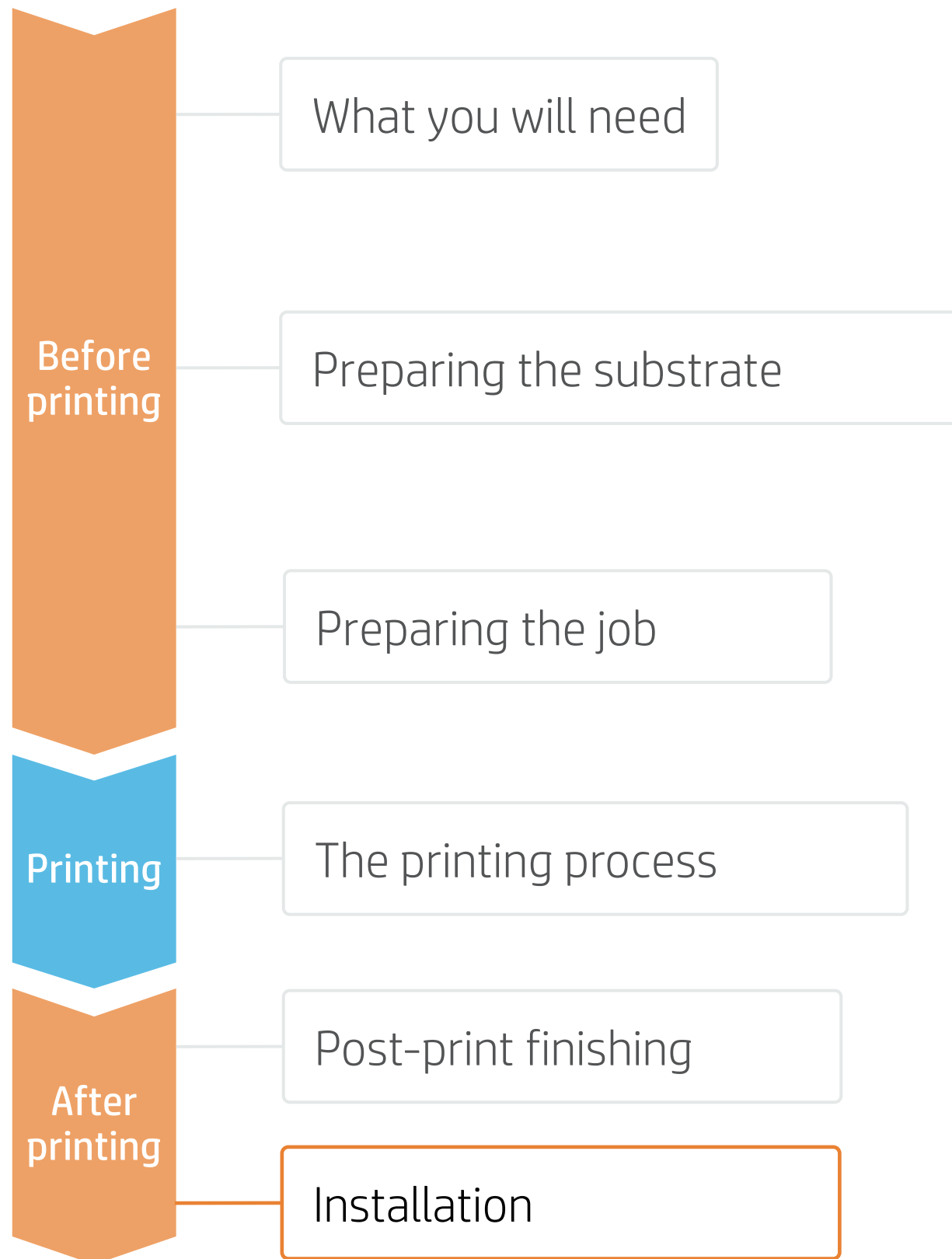

### 1. Different print&cut applications

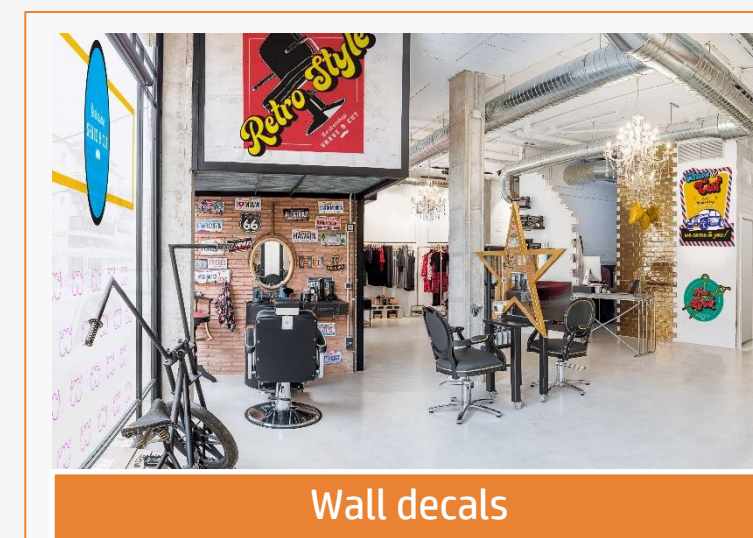

# How to create stickers

## Remarks

- Colorful and elegant stickers with sharper text.
- Cut borderless stickers with no curling.
- The new HP Latex inks are ideal for safe indoor applications. The newest HP Latex Inks are UL ECOLOGO and UL GREENGUARD GOLD certified, and conform to the Zero Discharge of Hazard Chemicals (ZDHC) manufacturing restricted substances list v1.1.
- We recommend protecting your prints with film lamination for long-term usage and high-transit areas.

### Learn more at:

- [HP Latex Knowledge Center](#)
- [Learn with HP](#)

### Certifications:

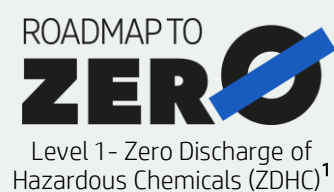

Inks meet stringent health and environmental criteria<sup>2</sup>



Unrestricted, full room. No-wait installation or lamination<sup>3</sup>

<sup>1</sup>Zero Discharge of Hazardous Chemicals. Applicable to HP Latex Inks. The ZDHC Roadmap to Zero Level 1 demonstrates that an ink conforms to or meets the standards of the ZDHC Manufacturing Restricted Substances List (ZDHC MRSL) 1.1, a list of chemical substances banned from intentional use during production. ZDHC is an organization dedicated to eliminating hazardous chemicals and implementing sustainable chemicals in the leather, textile, and synthetics sectors. The Roadmap to Zero Program is a multi-stakeholder organization which includes brands, value chain affiliates, and associates, that work collaboratively to implement responsible chemical management practices. See [roadmaptozero.com](https://roadmaptozero.com).

<sup>2</sup>Applicable to R Series and 700/800 Printer series HP Latex Inks. UL ECOLOGO® Certification to UL 2801 demonstrates that an ink meets a range of multi-attribute, lifecycle-based stringent criteria related to human health and environmental considerations (see [ul.com/EL](https://ul.com/EL)). HP is the only printing company with UL ECOLOGO® Certified inks in the "Printing Inks and Graphics Film" product category, see [spot.ul.com/main-app/products/catalog/](https://spot.ul.com/main-app/products/catalog/).

<sup>3</sup>Applicable to HP Latex Inks. UL GREENGUARD Gold Certification to UL 2818 demonstrates that products are certified to UL's GREENGUARD standards for low chemical emissions into indoor air during product usage. Unrestricted room size—full decorated room, 33.4 m<sup>2</sup> (360 ft<sup>2</sup>) in an office environment, 94.6 m<sup>2</sup> (1,018 ft<sup>2</sup>) in a classroom environment. For more information, visit [ul.com/gg](https://ul.com/gg) or [greenguard.org](https://greenguard.org).

### In partnership with:



